

1. Location

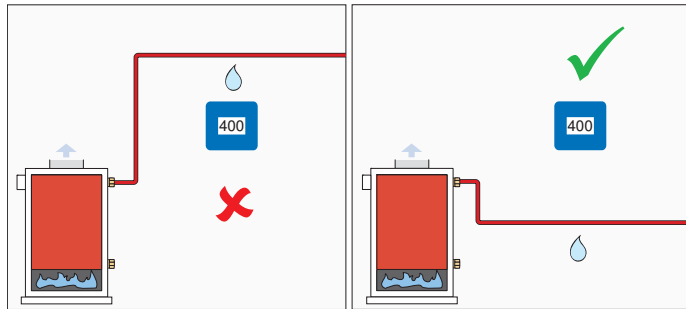

2. Install Junction Box

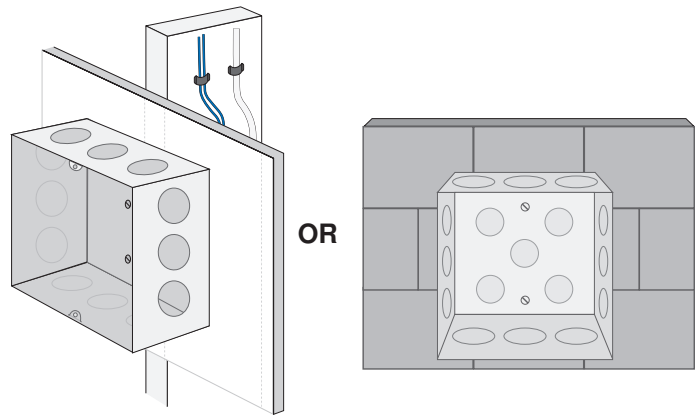

3. Size Transformer

Zone	1	2	3	4		
Thermostat Load						
Zone Valve Load					Floating Action (VA)	Control Load (VA)
Total Zone Load	+ _____	+ _____	+ _____	+ _____	+ _____	2

Transformer must exceed:
 _____ VA

4. Install Sensors

Outdoor Sensor

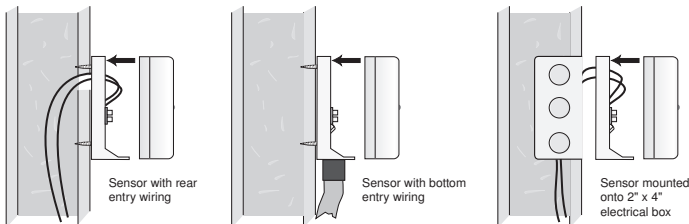

Pipe Sensors

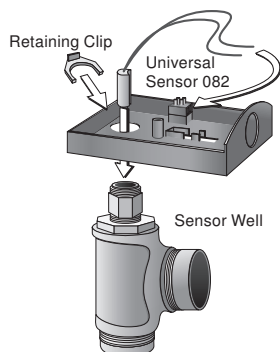
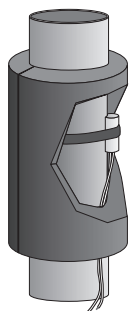

5. Line Voltage Wiring

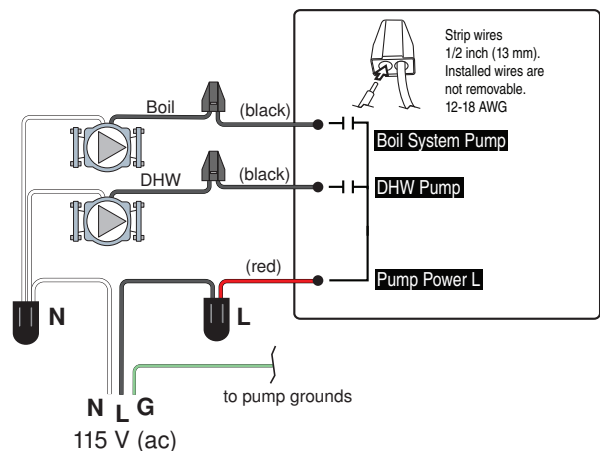

9. User Interface

Display

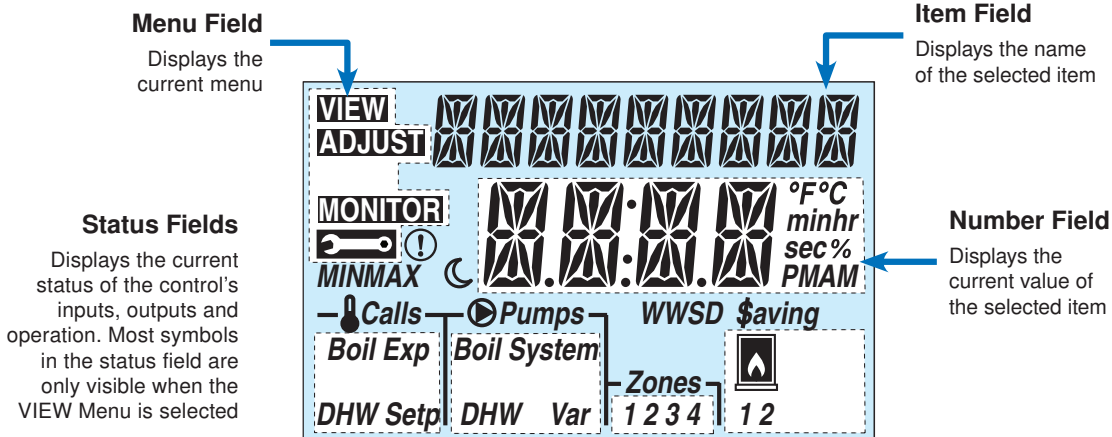

Symbols

Calls	CALLS Displays any call for heat the control is receiving.	WWSD	WWSD Displays when the system is in Warm Weather Shut Down.
Pumps	PUMPS Displays any pump currently operating.	°F °C minhr sec%	°F, °C, %, HOURS, MINUTES, SECOND Units of measurement for current number.
Zones 1 2 3 4	ZONES Displays if an on-board zone is operating.		UNOCCUPIED Indicates that a User Switch or Timer has put the system into UnOccupied.
	WARNING Displays if an error exists on the system.		BOILER Indicates that the boiler should be heating.
\$aving	ENERGY SAVING INDICATOR Displays when the system is saving energy. See the Saving Indicator section.	MINMAX	MIN / MAX Displays when an operating temperature reaches a minimum or maximum value.

10. Access Level

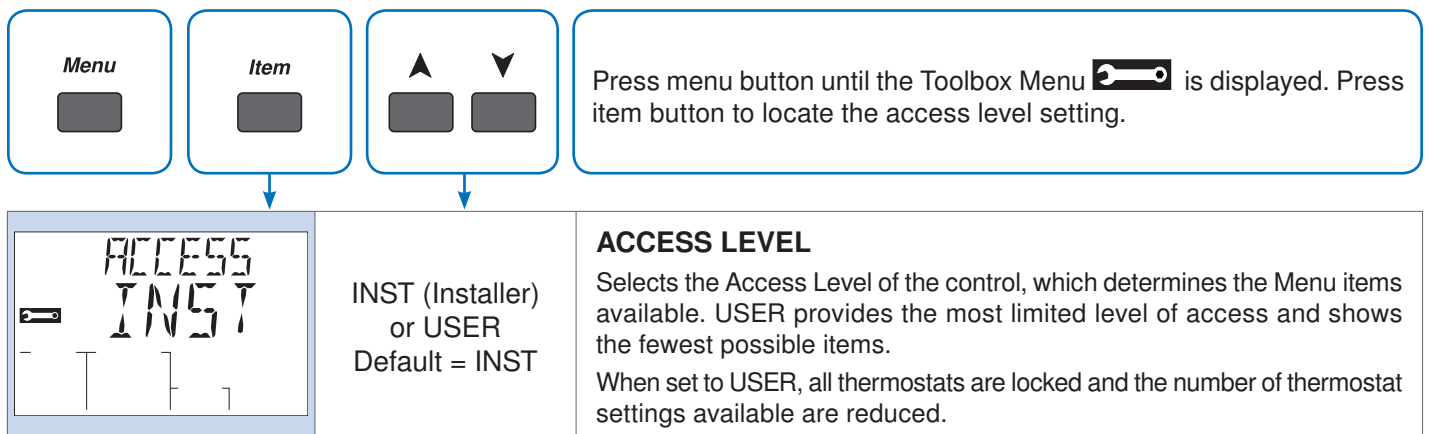

11. Critical Settings

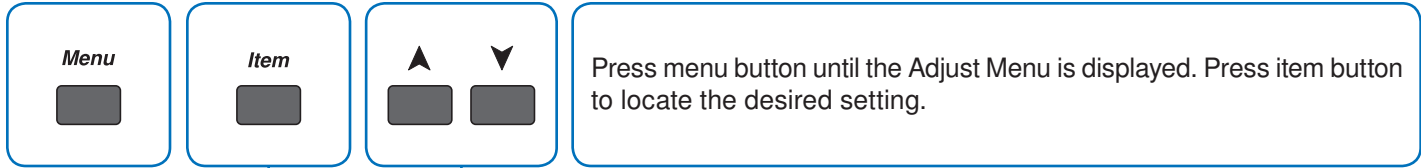

Item Field	Range	Access	Description	Set to
	-60 to 45 °F (-51.0 to 7.0 °C) Default = 10 °F (-12.0 °C)	Installer	OUTDOOR DESIGN Typically set to the temperature of the coldest day of the year. The outdoor air temperature used in the boiler heating curve is used to determine the boiler target temperature.	
	EMS2, EMS1, 4-20 0-10, 2STG, 1STG Default = 1STG	Installer	BOILER TYPE The type of boiler connected to the control. 1STG = single one-stage on-off boiler 2STG = single two-stage on-off boiler 0-10 = 0-10 V (dc) modulating boiler 4-20 = 4-20 mA modulating boiler EMS1 = tekmar boiler staging controls EMS2 = Viessmann modulating boilers with OpenTherm	
	70 to 200 °F (21.0 to 93.5 °C) Default = 180 °F (82.0 °C)	Installer	BOILER DESIGN The supply water temperature required for the boiler zones to heat the building on the typical coldest day of the year. Recommendations: High mass radiant floor = 120 °F (50 °C) Low mass radiant floor = 140 °F (60 °C) Fancoil or air handling unit = 190 °F (90 °C) Copper fin-tube convactor = 180 °F (80 °C) Radiators = 160 °F (70 °C) Low profile baseboard = 150 °F (65 °C)	



tekmar Control Systems Ltd., A Watts Water Technologies Company. Head Office: 5100 Silver Star Road, Vernon, B.C. Canada V1B 3K4, 250-545-7749, Fax. 250-545-0650 Web Site: www.tekmarControls.com



1. Emplacement

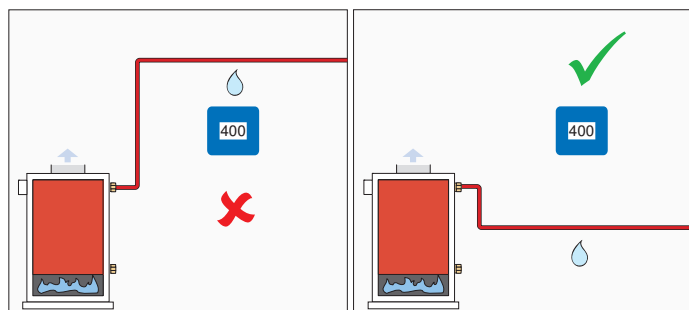

2. Installez la boîte de jonction

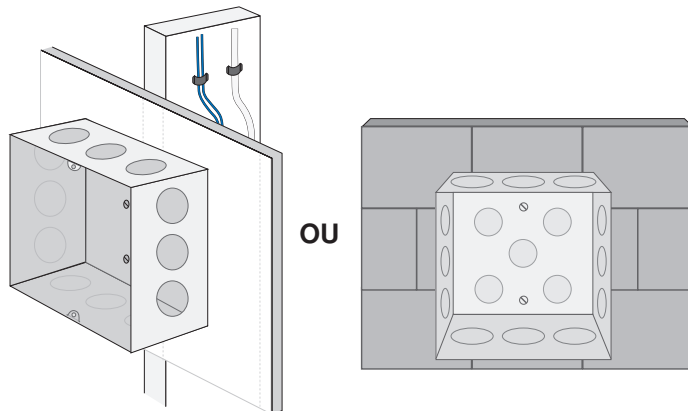

3. Transformateur de taille

Zone	1	2	3	4		
Charge de thermostat						
Charge de vannes de zone					Action flottante (VA)	Charge de contrôle (VA)
Charge de la zone totale	+ _____	+ _____	+ _____	+ _____	+ _____	2 =

Le transformateur doit dépasser: _____ VA

4. Installez des capteurs

Capteurs extérieurs

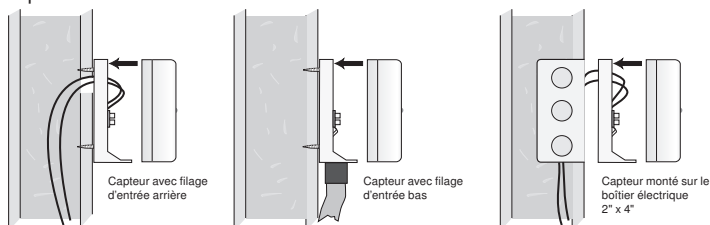

Capteurs de tuyau

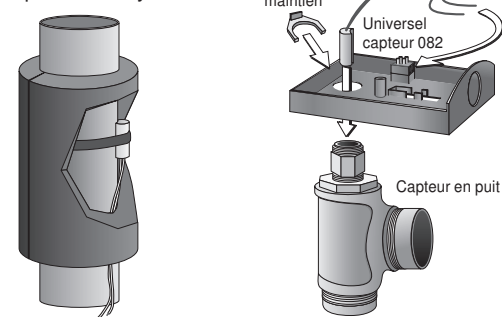

5. Filage ligne tension

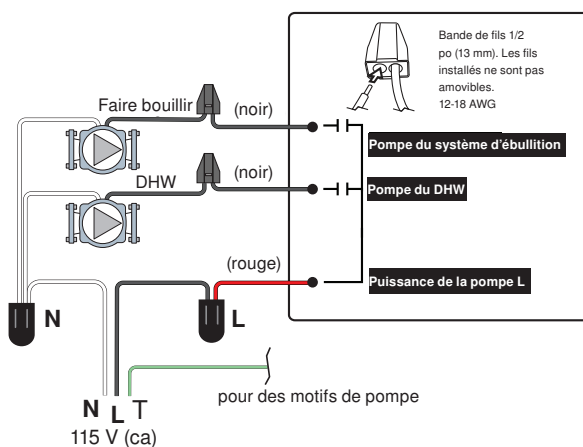

6. Installez le boîtier

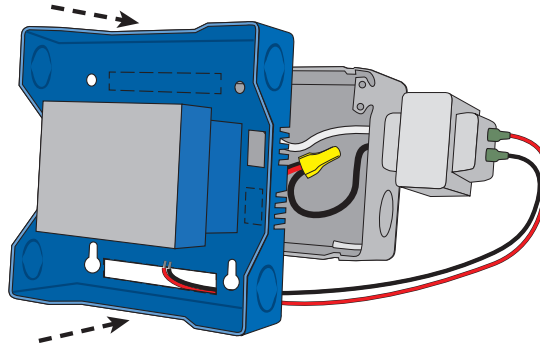

7. Filage basse tension

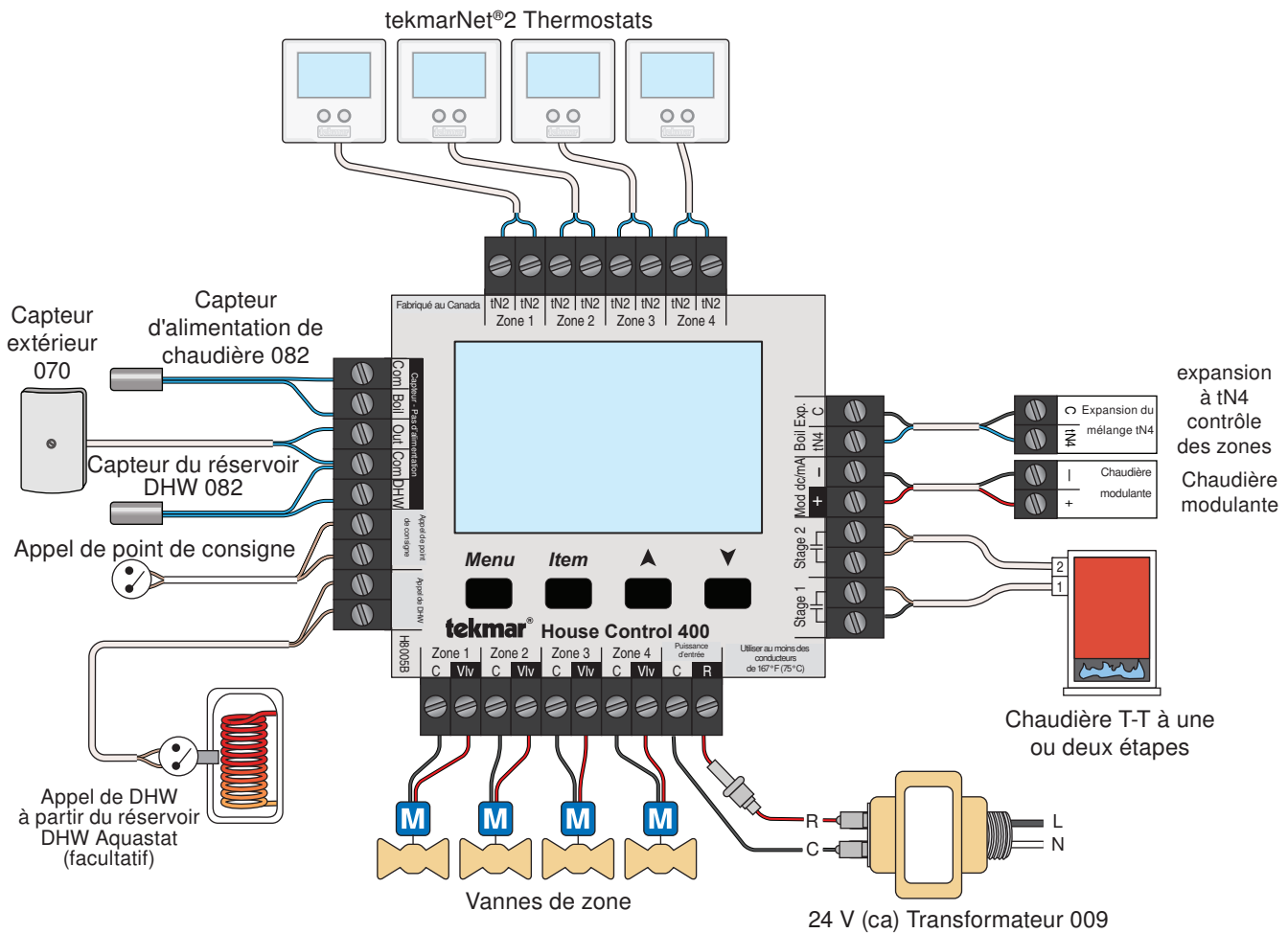

8. Installez le couvercle

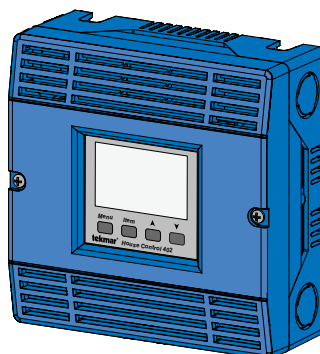

9. Interface d'utilisateur

Afficher

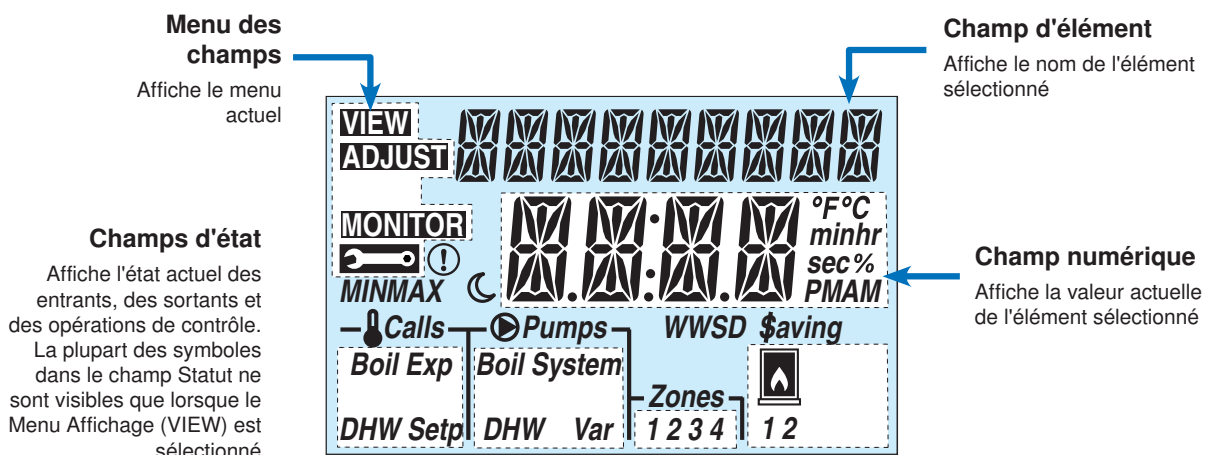

Symboles

	APPELS Affiche n'importe quel appel de chaleur que reçoit le contrôle.	WWSD	WWSD S'affiche lorsque le système s'arrête à cause d'un sur chauffage.
	POMPES Affiche n'importe quelle pompe actuellement en exploitation.	° C ° F minhr sec %	° F, ° C, %, HEURES, MINUTES, SECONDE Unités de mesure pour le nombre actuel.
Zones 1 2 3 4	ZONES S'affiche si une zone de bord est en marche.		INOCCUPÉ Indique qu'un interrupteur ou une minuterie de l'utilisateur a mis le système en Inoccupé.
	AVERTISSEMENT S'affiche si une erreur existe sur le système.		CHAUDIÈRE Indique que la chaudière devrait chauffer.
\$aving	INDICATEUR D'ÉCONOMIE D'ÉNERGIE S'affiche lorsque le système économise de l'énergie. Reportez-vous à la section de l'indicateur d'économie.	MINMAX	MIN / MAX S'affiche lorsqu'une la température de fonctionnement atteint une valeur minimale ou maximale.

10. Niveau d'accès

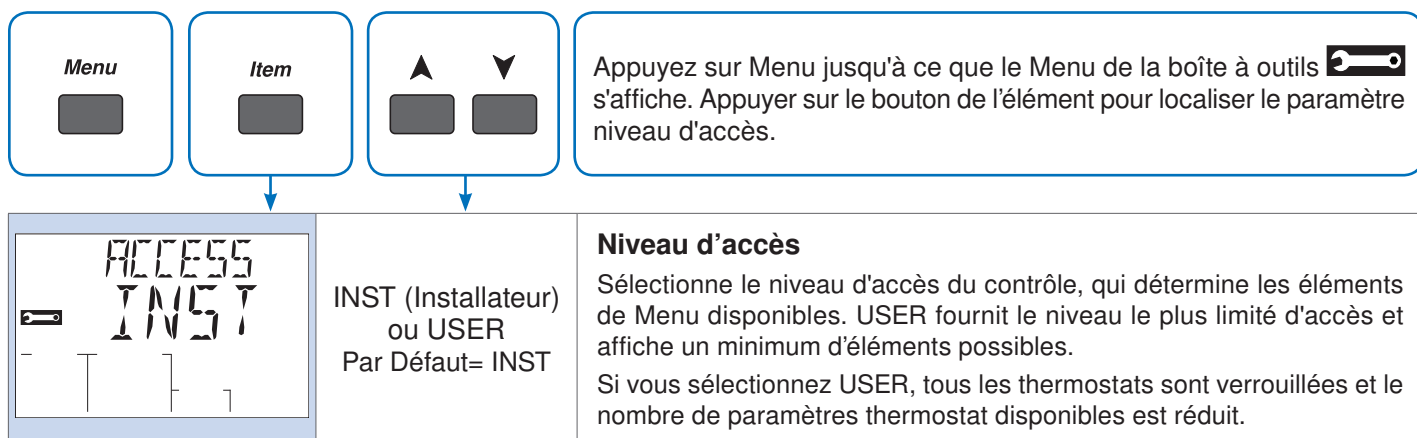

11. Paramètres critiques

Menu



Item



▲ ▼

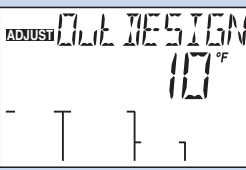
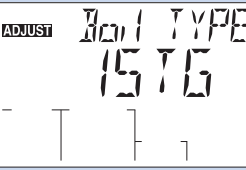
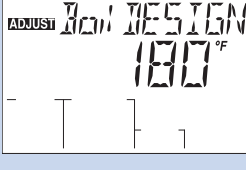

Appuyez sur Menu jusqu'à ce que le Menu de réglage soit affiché.
Appuyer sur le bouton de l'élément pour localiser la position désirée.

Champ d'élément	Gamme	Accès	Description	Réglez à
	-60 à 45°F (-51,0 à 7,0°C) Par défaut = 10°F (-12,0°C)	Installateur	OUT DESIGN (CONCEPTION EXTERIEURE) Généralement réglée à la température du jour le plus froid de l'année. La température de l'air extérieur utilisée dans la cuve de chauffage de la chaudière est utilisée pour déterminer la température de consigne chaudière.	
	EMS2, EMS1, 4-20 0-10, 2STG, 1STG Par défaut = 1STG	Installateur	BOIL TYPE (TYPE DE CHAUDIÈRE) Le type de chaudière relié à la commande. 1STG = chaudière à une étape unique marche-arrêt 2STG = chaudière à deux étapes marche-arrêt 0-10 = 0-10 V (cc) chaudière modulante 4-20 = 4-20 mA chaudière modulante EMS1 = contrôles de chaudière à étapes tekmar EMS2 = chaudières modulante Viessmann avec OpenTherm	
	70 à 200°F (21,0 à 93,5°C) Par défaut = 180°F (82,0°C)	Installateur	BOIL DESIGN (CONCEPTION DE LA CHAUDIÈRE) La température de l'eau d'alimentation requise pour les zones de la chaudière afin chauffer le bâtiment sur le jour le plus froid typique de l'année. Recommandations: Sol chauffant à haute masse = 120°F (50°C) Sol chauffant à faible masse = 140°F (60°C) Ventilateur-convecteur ou unité de traitement d'air = 190°F (90°C) Convecteur avec tubes à ailettes de cuivre = 180°F (80°C) Radiateurs = 160°F (70°C) Plinthe à profil bas = 150°F (65°C)	



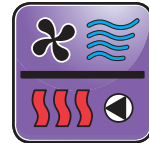

Sistemas de HVAC (Climatización)

400_Q
02/14

Remplazado por: 01/14

1. Ubicación

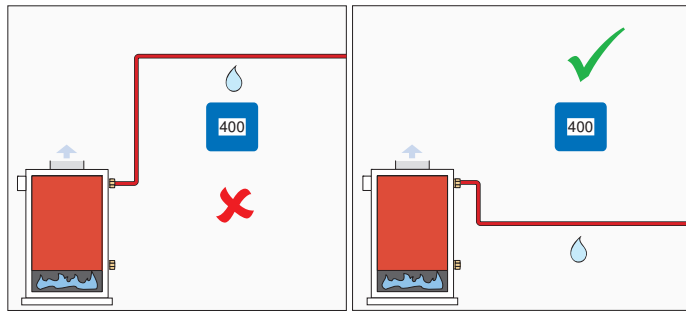

2. Instalación de la caja de unión

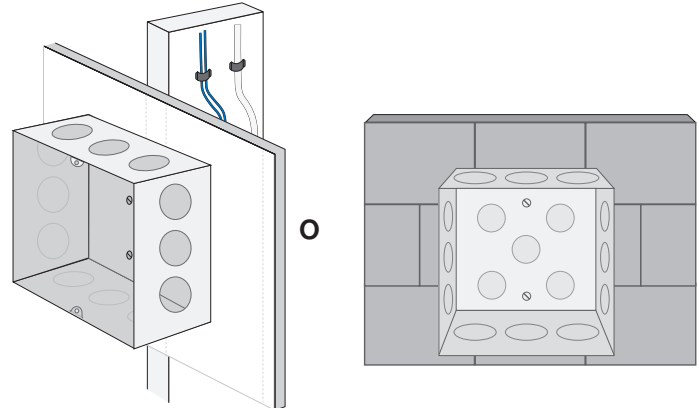

3. Tamaño del transformador

Zona	1	2	3	4		
Carga del termostato						
Carga de la válvula de la zona					Actuador de acción flotante (VA)	Carga de control (VA)
Carga total de la zona	+ _____	+ _____	+ _____	+ _____	+ _____	2

El transformador debe exceder: _____ VA

4. Instalación sensores

Sensor de exterior

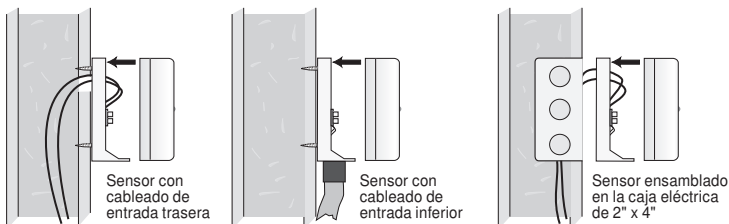

Sensores de cañerías

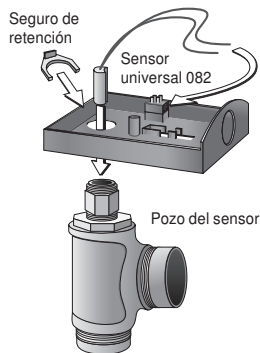
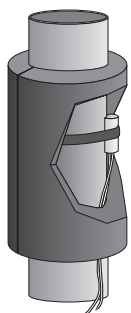

5. Cableado de la línea de voltaje

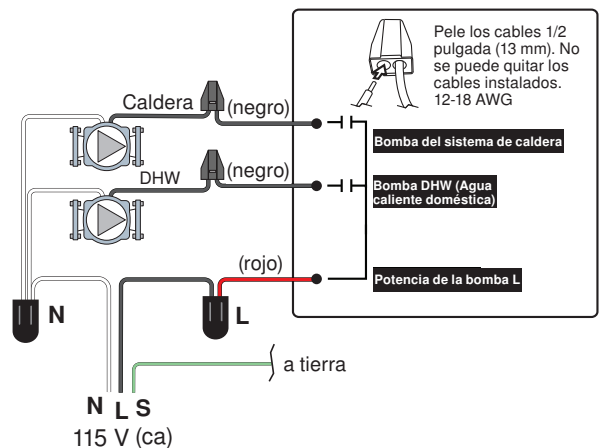

6. Instalación de la caja protectora

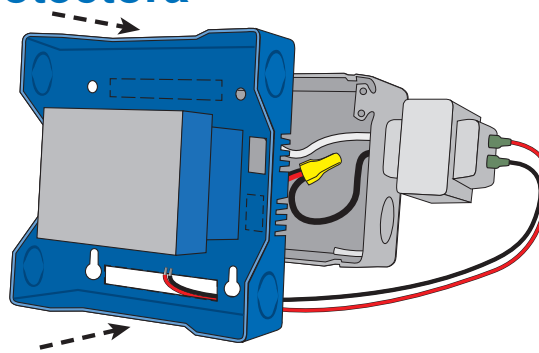

7. Cableado de bajo voltaje

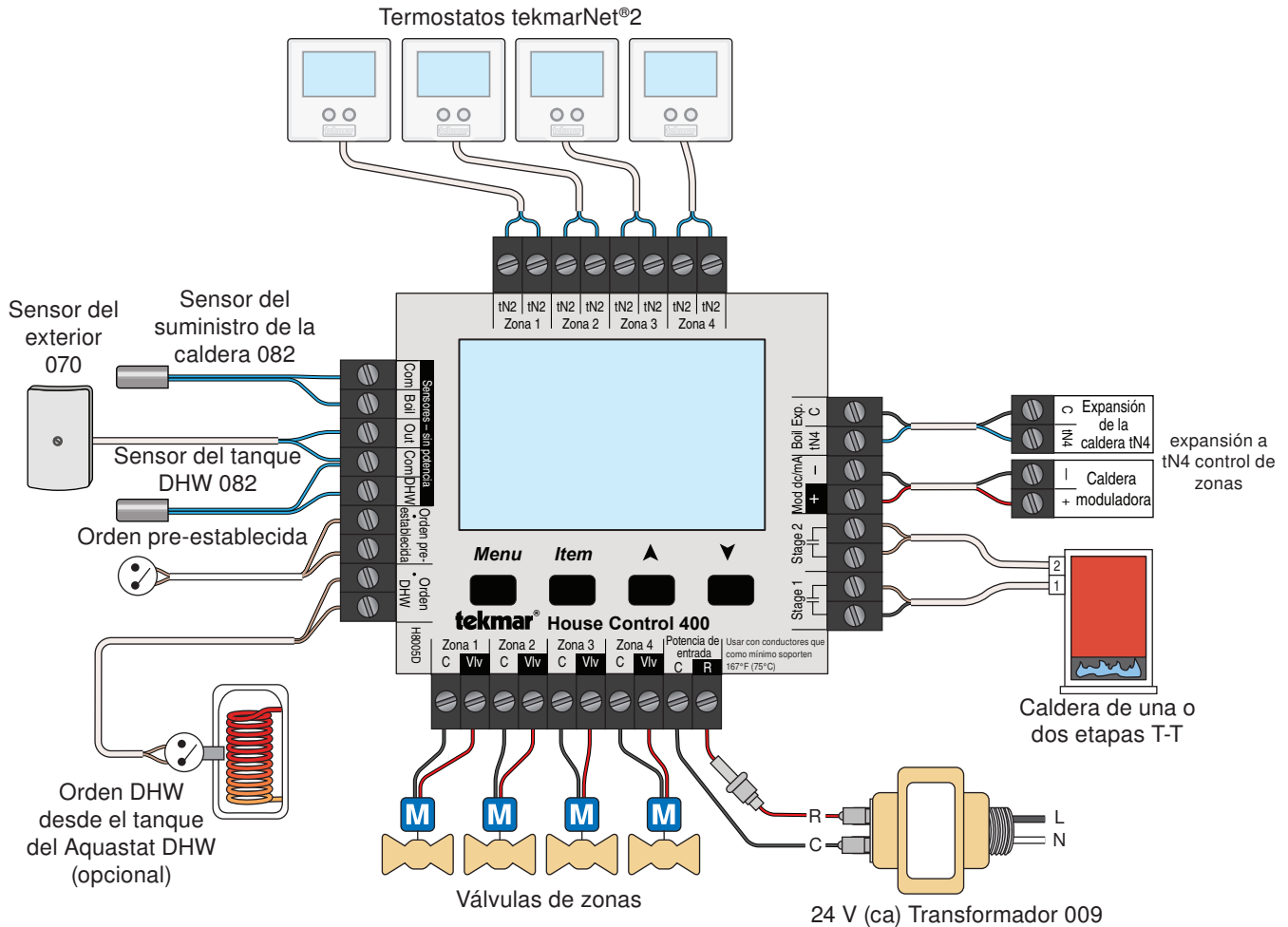

8. Instalación de la tapa

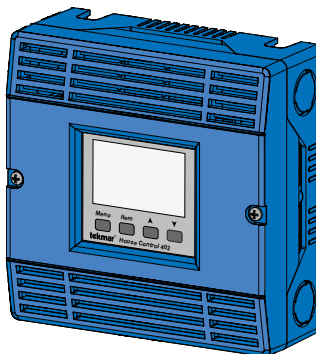

9. Interfaz del usuario

Pantalla

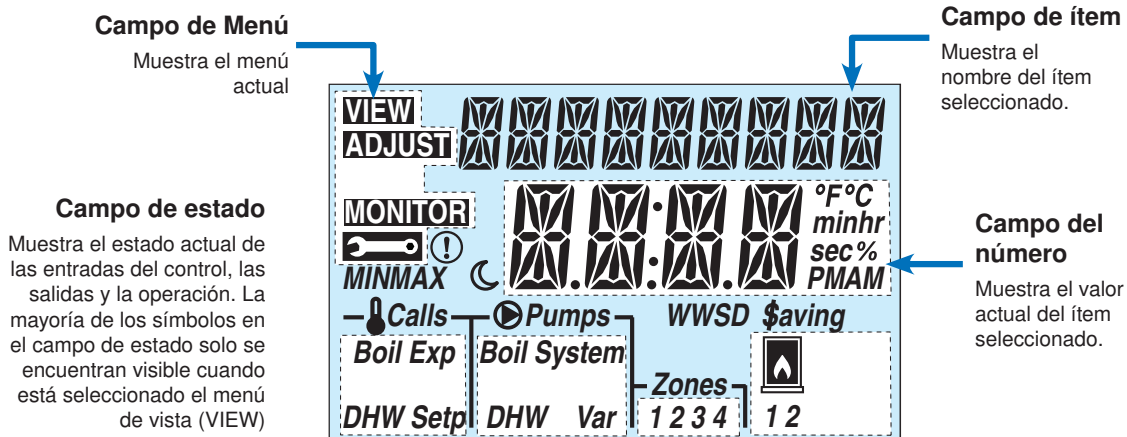

Símbolos

	ORDENES Muestra cualquier orden de calefacción.	WWSD	WWSD (DESCONEXIÓN POR CLIMA CÁLIDO) Muestra cuando el sistema se encuentra trabajando bajo el método de desconexión por clima cálido.
	BOMBAS Muestra cualquier bomba que se encuentra trabajando en ese momento.	°F °C minhr sec%	°F, °C, %, HORAS, MINUTOS, SEGUNDOS Unidades de medida para un número actual.
Zones 1 2 3 4	ZONAS Muestra si una zona a bordo se encuentra trabajando.		LIBRE Indica que un interruptor del usuario o un temporizador han puesto el sistema en modo Libre.
	ADVERTENCIA Muestra si hay un error en el sistema.		CALDERA Indica que la caldera tendría que estar emitiendo calor.
\$aving	INDICADOR DE AHORRO DE ENERGÍA Muestra cuando el sistema se encuentra ahorrando energía. Véase la sección del Indicador de ahorro.	MINMAX	MIN / MAX Muestra cuando la temperatura que se encuentra en pantalla llega a un mínimo o a un máximo.

10. Nivel de acceso

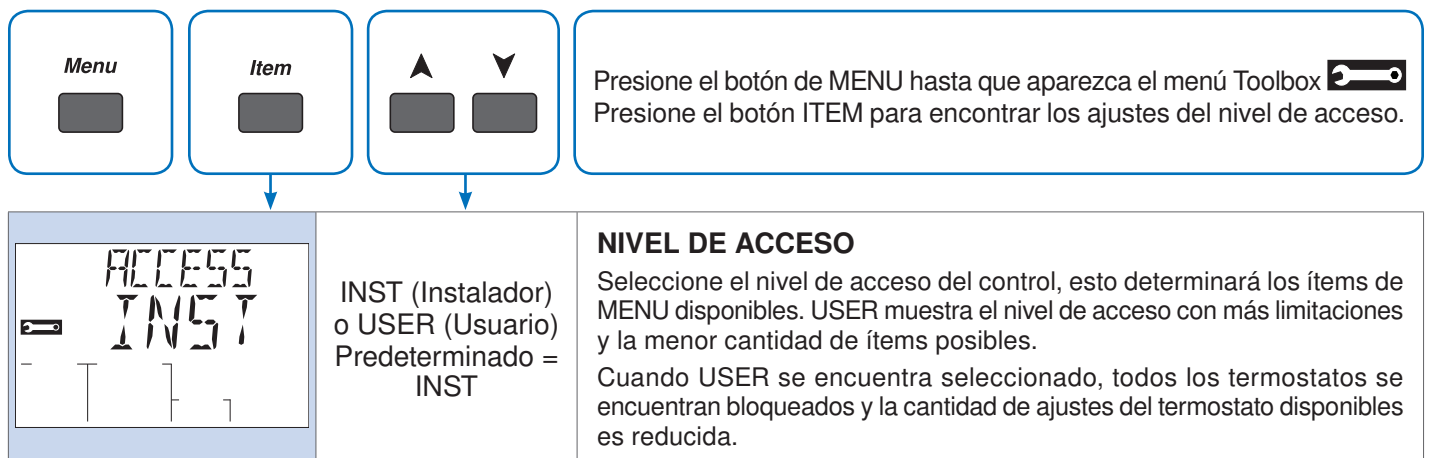

11. Ajustes críticos

Menu



Item



▲ ▼

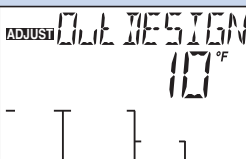
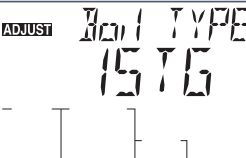
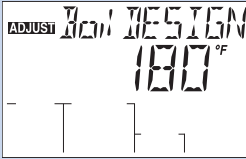

Presione el botón MENU hasta que se muestre el menú ADJUST MENU (Menú de ajustes). Presione el botón ITEM para encontrar los ajustes deseados.

Campo de ítem	Rango	Acceso	Descripción	Fijar en
	-60 a 45°F (-51,0 a 7,0°C) Predeterminado = 10°F (-12,0°C)	Instalador	OUT DESIGN (TEMPERATURE EXTERIOR DE DISEÑO) Normalmente establecido en el día más frío del año. La temperatura del aire en el exterior que se utiliza en la curva la calefacción de la caldera determinará la temperatura buscada de la caldera.	
	EMS2, EMS1, 4-20 0-10, 2STG, 1STG Predeterminada = 1STG	Instalador	BOIL TYPE (TIPO DE CALDERA) El tipo de caldera conectada al control. 1STG = única caldera de comando de una etapa 2STG = única caldera de comando de dos etapas 0-10 = 0-10 V (cc) caldera con modulación 4-20 = 4-20 mA caldera con modulación EMS1 = tekmar controles de etapas de la caldera EMS2 = calderas con modulación Viessmann y OpenTherm	
	70 a 200°F (21,0 a 93,5°C) Predeterminada = 180°F (82,0°C)	Instalador	BOIL DESIGN (DISEÑO DE LA CALDERA) La temperatura del suministro de agua para las zonas de calderas necesaria para calentar las instalaciones en el día más frío del año. Recomendaciones: Piso de losa radiante de alto rendimiento = 120°F (50°C) Piso de losa radiante de bajo rendimiento = 140°F (60°C) Fancoil o climatizador (air handling unit) = 190°F (90°C) Convector de aletas y tubos de cobre = 180°F (80°C) Radiadores = 160°F (70°C) Zócalo discreto = 150°F (65°C)	

