

<b>1</b>	<b>2</b>	<b>3</b>	<b>4</b>	<b>5</b>	<b>6</b>
<b>Information Brochure</b>	<b>Application Brochure</b>	<b>Rough-in Wiring</b>	<b>Wiring Brochure</b>	<b>Data Brochure</b>	<b>Job Record</b>
Choose controls to match application	Design your mechanical applications	Rough-in wiring instructions	Wiring and installation of specific control	Control settings and sequence of operation	Record settings & wiring details for future reference

## Introduction

The Universal Reset Module 422 provides outdoor reset to a hydronic heating system in order to maximize comfort and efficiency. The 422 can operate a single on / off boiler or a single modulating boiler. The 422 can override the outdoor reset water temperature to provide Domestic Hot Water or Setpoint operations. The 422 can operate two outdoor reset water temperatures, either one boiler water temperature and a single mix water temperature, or two mix water temperatures. To operate two mixing devices, a Mixing Expansion Module must be connected to the 422. The single mix output can operate a floating action mixing valve or a variable speed injection pump.

## Features:

- tN4 Compatible
- Two Outdoor Reset Temperatures
- Single On-Off or Modulating Boiler
- Powered Pump Outputs
- DHW Operation
- Variable Speed Injection Pump
- Floating Action Valve
- Includes Sensors

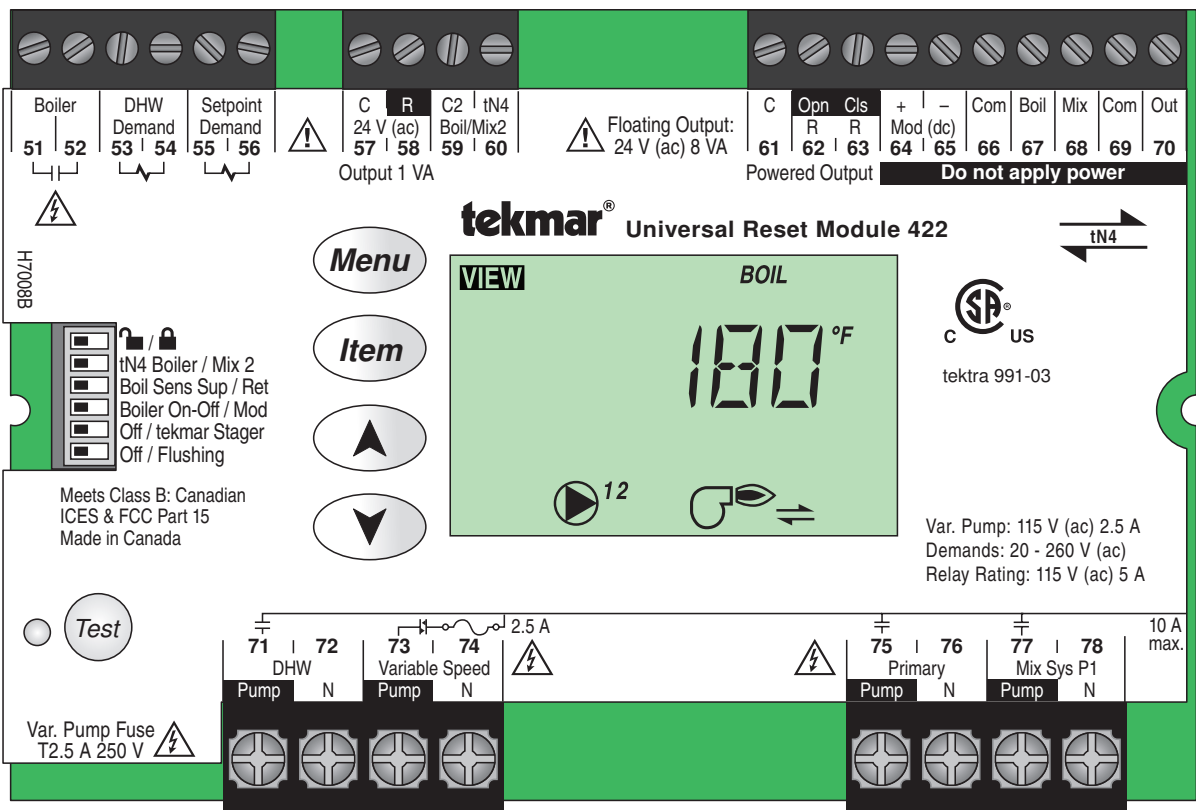

## Table of Contents

Table of Contents .....	2	Boiler Temperature Control .....	19
Display and DIP Switches .....	2	tekmar Stager Operation .....	21
Dip Switch Settings .....	2	Boil Enable.....	22
Access Level.....	3	Direct Fired - DHW Tank as a Heat Source .....	22
Display and Symbols Description.....	4	Zone Load Shedding .....	22
User Interface .....	5	Mixing Operation .....	22
Display Menus.....	6	Domestic Hot Water Temperature Operation .....	23
View Menu .....	6	DHW with Low Temperature Boilers .....	25
Adjust Menu .....	8	Setpoint Temperature Operation.....	25
Miscellaneous Menu .....	13	Pump Operation.....	27
Testing the Control .....	14	Pump Exercising .....	27
Sequence of Operation.....	16	Error Messages .....	28
tekmarNet®4 Communication .....	16	Troubleshooting .....	31
Outdoor Reset .....	16	Warranty .....	32

## Display and DIP Switches

### Dip Switch Settings

Set the DIP switch settings prior to making adjustments to the control through the user interface. Setting the DIP switches determines which menu items are displayed in the user interface.

If you change a DIP switch setting while the control is powered up, the LCD display returns to the View menu.

### Lock / Unlock

Use the Lock / Unlock DIP switch to lock and unlock the Access Level of the 422 and all connected tN4 devices, including tN4 thermostats. For details, see “Access Levels”

- Once locked, the access level in all devices cannot be viewed or changed.
- To determine if the control is currently locked a small segment representing a padlock is viewed in the bottom right hand corner of the display.
- To unlock the Access Level, set the DIP switch to Unlock.
- To lock the Access Level, set the DIP switch to Lock.

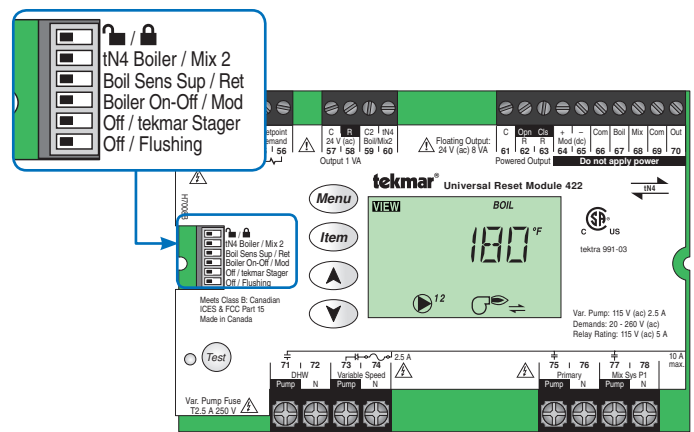

## **tN4 Boiler / Mix 2**

Use the tN4 Boiler / Mix 2 DIP switch to select whether the second tN4 bus (terminals 59-60) is to operate as a boiler water temperature or as a second mixing water temperature.

- If set to Boiler, this creates a system with one boiler and one mix water temperature.
- If set to Mix 2, this creates a system with two mix water temperatures. If Mix 2 is selected, a mixing expansion module must be connected to the Boiler / Mix 2 bus.

## **Boiler Sup / Ret**

Use the Boiler Sensor Supply / Return DIP switch to select the location of the boiler sensor.

- If the boiler sensor is located on the supply, this DIP switch should be set to Sup. The 422 is the control that determines the boiler water temperature. Set the boiler's aquastat at least 20°F (11.0°C) higher than the Boiler Maximum setting.
- If the 422 provides a heat demand to an external boiler control, this DIP switch must be set to Ret. Install the boiler sensor on the return side of the boiler loop. The boiler's operating temperature is controlled by its aquastat, or an external boiler reset control.

## **Boil On-Off / Mod**

The Boil On-Off / Mod DIP switch selects whether the control operates an On-Off boiler or the firing rate of a Modulating boiler.

- If set to Boil On-Off, the control operates an On-Off boiler.
- If set to Mod, the control operates a Modulating boiler.

## **Off / Flushing**

The Off / Flushing DIP switch selects whether the control operates a Flushing feature. Heating systems that use potable water require periodic flushing to prevent the water from stagnating.

The flushing operation occurs if any zone has not operated for 7 days. All zones, mixing device(s), and applicable system pumps are turned on for 4 minutes.

- To activate the Flushing feature, set to Flushing.
- To deactivate the Flushing feature, set to Off.

## **tekmar Stager / Off**

Use the tekmar Stager / Off DIP switch when a tekmar staging control is be connected to the 422 in order to operate multiple boilers. A tekmar stager may include Boiler Controls 264, 265, and 268.

- If a tekmar Stager is installed, set to tekmar Stager. The 422 will then provide the stager with a target temperature via a 0-10 V (dc) signal. When the tekmar Stager / Off DIP switch is set to tekmar Stager, the Boiler Sensor DIP switch must be set to Sup.
- If a tekmar Stager is not installed, set to Off.

## **Access Level**

The Access Level restricts the number of Menus, Items, and Adjustments that can be accessed by the user. The Access Level setting is found in the Miscellaneous (MISC) menu. Select the appropriate access level for the people who work with the control on a regular basis.

There are two Access Level settings:

- Installer (InS): This is the factory default setting. This access level is sufficient for the normal set up of the control.
- Advanced (Ad): All of the control settings are available to the user.

In the following menu tables, the access level the item is visible in is shown in the access column.

## Display

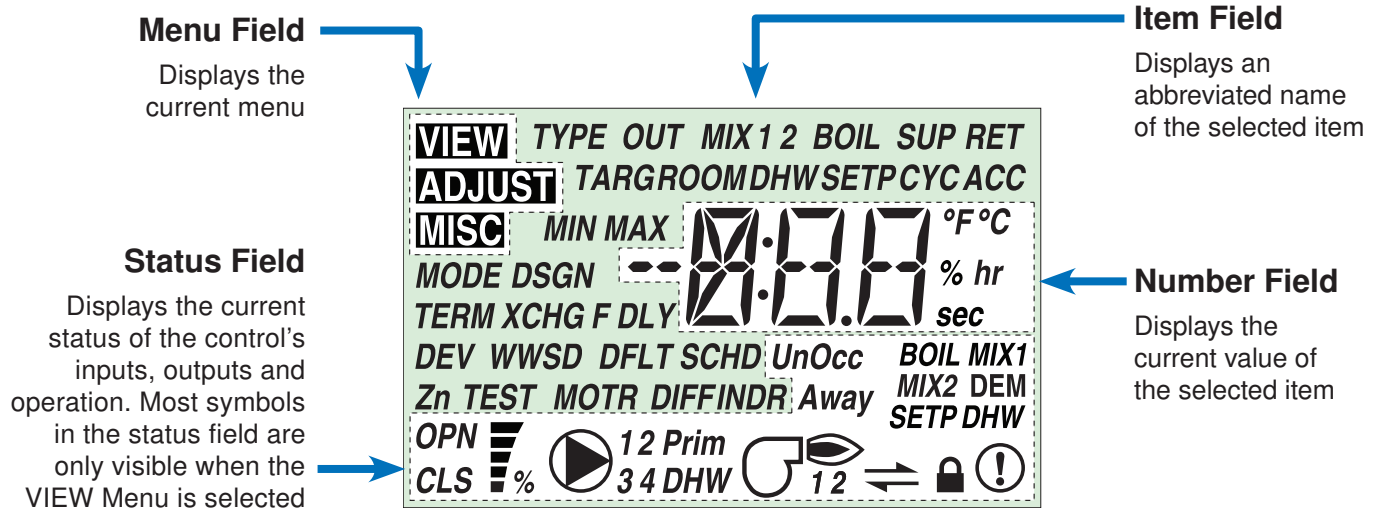

## Symbols Description

<b>12 Prim</b>	<b>PUMP</b> Displays when the primary or mixing pump is in operation.	<b>BOIL DEM</b>	<b>BOILER DEMAND</b> Displays when a boiler demand is present.
	<b>BURNER</b> Displays when the burner contact is closed.	<b>MIX1 DEM</b>	<b>MIX 1 DEMAND</b> Displays when a mix 1 demand is present.
	<b>LOCK</b> Displays when the access levels are locked.	<b>MIX2 DEM</b>	<b>MIX 2 DEMAND</b> Displays when a mix 2 demand is present.
	<b>WARNING</b> Displays when an error exists.	<b>DEM DHW</b>	<b>DHW DEMAND</b> Displays when a DHW demand is present.
	<b>COMMUNICATION BUS</b> Displays when tN4 thermostats are connected.	<b>SETP DEM</b>	<b>SETPOINT DEMAND</b> Displays when a Setpoint demand is present.
<b>DHW</b>	<b>DHW PUMP</b> Displays when the DHW Pump is in operation.		<b>DEVICE OUTPUT SCALE</b> Displays output of the modulating boiler, injection pump, or mixing valve.
<b>°F °C</b> <b>% hr</b> <b>sec</b>	<b>°F, °C, %, HOURS, MINUTES</b> Units of measurement.	<b>OPN</b> <b>CLS</b>	<b>OPEN / CLOSE</b> Displays whether the actuator is opening or closing the mixing valve.

## User Interface

Use the User Interface available on the Liquid Crystal Display (LCD) to setup and monitor the operation of the system. Use the four push buttons to the left of the LCD (Menu, Item, Up, Down) to select settings. As you enter settings, record the settings in the Job Record J 422.

### Menu

The menus display in the Menu Field at the top left side of the LCD. Three menus are available: View, Adjust, and Miscellaneous.

- To select a menu, press and release the Menu button.

### Item

In each menu, a group of items can be selected. The abbreviated name of the selected item displays in the Item field of the LCD display.

- To view the next available item, press and release the Item button.
- To view the previous item, hold down the Item button, and press and release the Up button.

## Adjusting a Setting

To adjust a setting:

- Select the appropriate menu using the Menu button.
- Select the item using the Item button.
- Use the Up or Down button to make the adjustment.

### Default Item

- To set the default item in the View menu, display the item for more than five seconds.

After navigating menus, the display reverts back to the default item after 60 seconds of button inactivity.

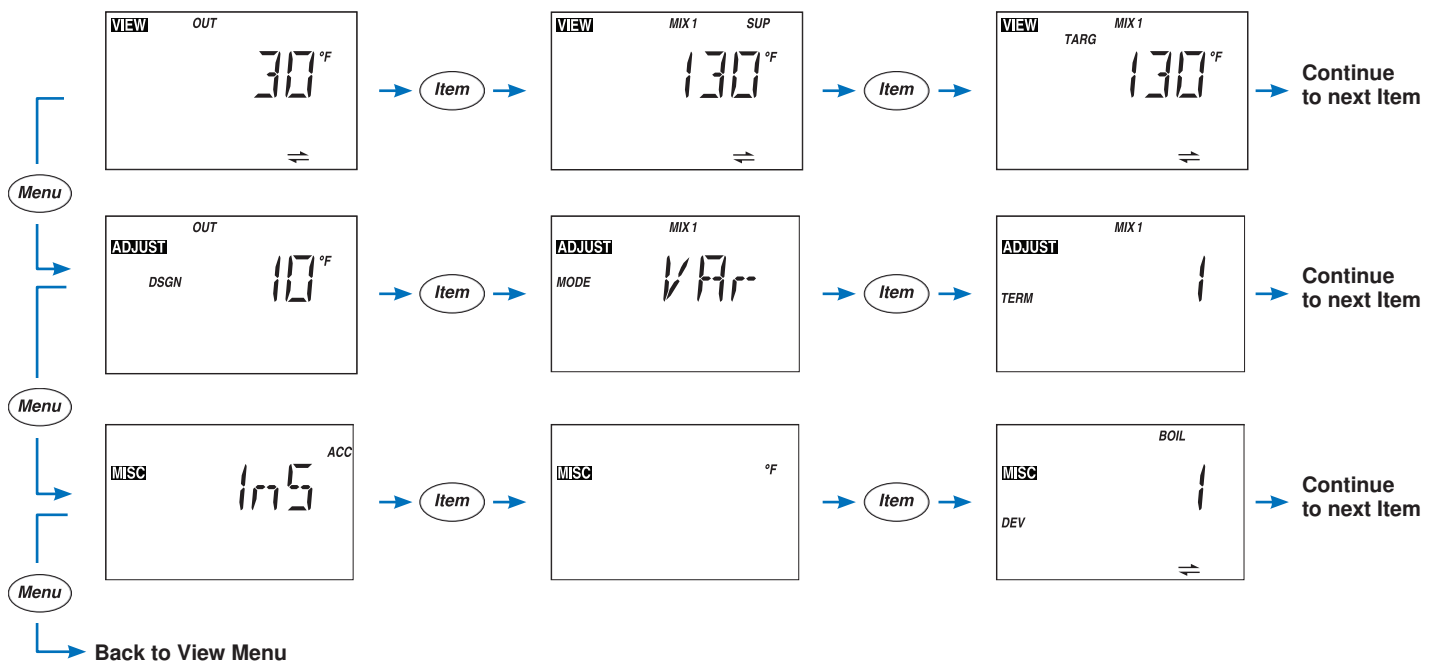

# Display Menus





## View Menu (1 of 2)

Menu

Item

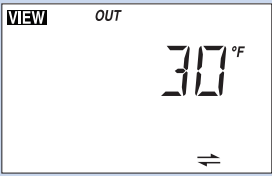
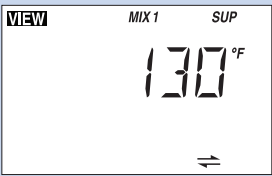
The View menu items display the current operating temperatures and status information of the system.

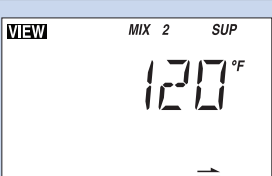
VIEW MENU

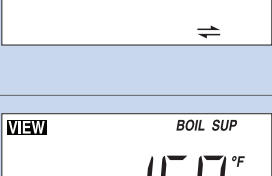
Item Field	Range	Access	Description
	-76 to 149°F (-60.0 to 65.0°C)	InS Ad	<b>OUTDOOR</b> <i>SECTION B</i> Current outdoor air temperature as measured by the outdoor sensor.
	-22 to 266°F (-30.0 to 130.0°C)	InS Ad	<b>MIX 1 SUPPLY</b> <i>SECTION B</i> Current Mix 1 supply water temperature as measured by the Mix 1 supply sensor.
	---, 35 to 230°F (---, 1.5 to 110.0°C)	Ad	<b>MIX 1 TARGET</b> <i>SECTION C</i> The Mix 1 target is the temperature the control is currently trying to maintain at the Mix 1 supply sensor. "—" is displayed when no heat is required for Mix 1 zones.
	-22 to 266°F (-30.0 to 130.0°C)	InS Ad	<b>MIX 2 SUPPLY</b> <i>SECTION B</i> Current Mix 2 supply water temperature as measured by the Mix 2 supply sensor. <b>Note:</b> This item is only available when the tN4 DIP switch is set to Mix 2.
	---, 35 to 230°F (---, 1.5 to 110.0°C)	Ad	<b>MIX 2 TARGET</b> <i>SECTION C</i> The mix 2 target is the temperature the control is currently trying to maintain at the Mix 2 supply sensor. "—" is displayed when no heat is required for mix 2 zones. <b>Note:</b> This item is only available when the tN4 DIP switch is set to Mix 2.
	-22 to 266°F (-30.0 to 130.0°C)	InS Ad	<b>BOILER SUPPLY</b> <i>SECTION C</i> Current boiler supply water temperature as measured by the boiler sensor. <b>Note:</b> This item is only available when the Boiler Sensor Sup / Ret DIP switch is set to Sup.

Continued on next page.

## View Menu (2 of 2)

VIEW MENU

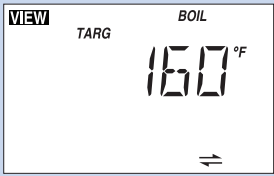
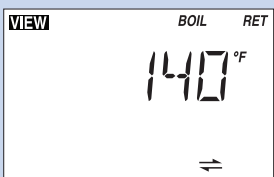
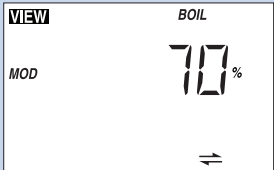
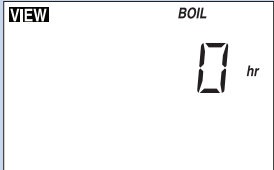
Item Field	Range	Access	Description
	<p>---, 35 to 230°F (---, 1.5 to 110.0°C)</p>	Ad	<p><b>BOILER TARGET</b> <span style="float: right;"><i>SECTION C</i></span></p> <p>The boiler target is the temperature the control is currently trying to maintain at the boiler supply sensor. “---” is displayed when no heat is required for boiler zones.</p> <p><b>Note:</b> This item is only available when the Boiler Sensor Sup / Ret DIP switch is set to Sup.</p>
	<p>-22 to 266°F (-30.0 to 130.0°C)</p>	InS Ad	<p><b>BOILER RETURN</b> <span style="float: right;"><i>SECTION G</i></span></p> <p>Current boiler return water temperature as measured by the boiler sensor.</p> <p><b>Note:</b> This item is only available when the Boiler Sensor Sup / Ret DIP switch is set to Ret.</p>
	<p>0-100%</p>	Ad	<p><b>BOILER MODULATION</b> <span style="float: right;"><i>SECTION C</i></span></p> <p>Current percent modulation of the boiler’s burner.</p> <p><b>Note:</b> This item is only available when the Boiler On-Off / Mod DIP switch is set to Mod, and the Boiler Sensor Sup / Ret DIP switch is set to Sup.</p>
	<p>0 to 9999 hr</p>	InS Ad	<p><b>BOILER</b></p> <p>The total running time of the boiler since this item was last cleared. To clear this item, press the Up and Down buttons simultaneously while viewing this item.</p> <p><b>Note:</b> This item is only available when the Boiler Sensor Sup / Ret DIP switch is set to Sup.</p>

• After the last item, the control returns to the first item in the menu.

## Adjust Menu (1 of 5)

Menu

Item



The Adjust Menu items are the programmable settings used to operate the mechanical equipment.

ADJUST MENU





Item Field	Range	Access	Description
<p>OUT</p> <p><b>ADJUST</b></p> <p>DSGN</p> <p>10 °F</p>	<p>-60 to 45 °F (-51.0 to 7.0 °C) Default = 10 °F (-12.0 °C)</p>	<p>InS Ad</p>	<p><b>OUTDOOR DESIGN</b> <i>SECTION B</i></p> <p>The design outdoor air temperature used in the heat loss calculations for the heating system. Typically set to the temperature of the coldest day of the year.</p>
<p>MIX 1</p> <p><b>ADJUST</b></p> <p>MODE</p> <p>VAr</p>	<p>VAr, FLt Default = VAr</p>	<p>InS Ad</p>	<p><b>MIX 1 MODE</b> <i>SECTION G</i></p> <p>Select the type of mixing device to be used for Mix 1. Options are variable speed injection pump (VAr) or floating action (FLt).</p>
<p>MIX 1</p> <p><b>ADJUST</b></p> <p>TERM</p> <p>1</p>	<p>1 HRF1 2 HRF2 3 Fancoil 4 Fin-tube Convector 5 Radiator 6 Baseboard Default = 1</p>	<p>InS Ad</p>	<p><b>MIX 1 TERMINAL</b> <i>SECTION B</i></p> <p>The type of heating terminal units that are being used in Mix 1 zones.</p>
<p>MIX 1</p> <p><b>ADJUST</b></p> <p>INDR</p> <p>70 °F</p>	<p>40 to 100 °F (4.5 to 38.0 °C) Default = 70 °F (21.0 °C)</p>	<p>Ad</p>	<p><b>MIX 1 INDOOR</b> <i>SECTION B</i></p> <p>The design indoor air temperature used in the heat loss calculation for Mix 1 zones. Typically set to 70 °F (21.0 °C).</p>
<p>MIX 1</p> <p><b>ADJUST</b></p> <p>DSGN</p> <p>120 °F</p>	<p>70 to 220 °F (21.0 to 104.5 °C) Default = 120 °F (49.0 °C)</p>	<p>InS Ad</p>	<p><b>MIX 1 DESIGN</b> <i>SECTION B</i></p> <p>The supply water temperature required for the Mix 1 zones on the typical coldest day of the year.</p>
<p>MIX 1</p> <p><b>ADJUST</b></p> <p>MIN</p> <p>OFF</p>	<p>OFF, 40 to 150 °F (OFF, 4.5 to 65.5 °C) Default = OFF</p>	<p>Ad</p>	<p><b>MIX 1 MINIMUM</b> <i>SECTION G</i></p> <p>The minimum allowed Mix 1 target temperature.</p>
<p>MIX 1</p> <p><b>ADJUST</b></p> <p>MAX</p> <p>140 °F</p>	<p>80 to 220 °F, OFF (26.5 to 104.5 °C, OFF) Default = 140 °F (60.0 °C)</p>	<p>Ad</p>	<p><b>MIX 1 MAXIMUM</b> <i>SECTION G</i></p> <p>The maximum allowed Mix 1 target temperature.</p>

Continued on next page.



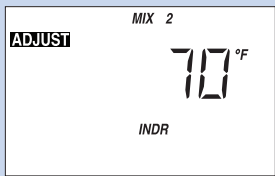

## Adjust Menu (2 of 5)

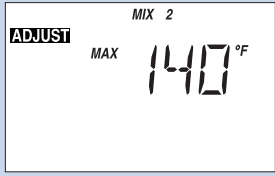
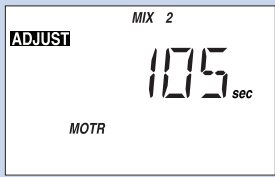
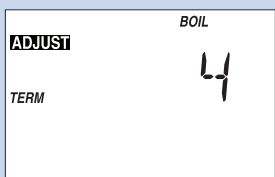
### ADJUST MENU

Item Field	Range	Access	Description
 <p>MIX 1 ADJUST 105<sub>sec</sub> MOTR</p>	30 to 230 seconds Default = 105	Ad	<b>MIX 1 MOTOR</b> <a href="#">SECTION G</a> The time that the Mix 1 actuating motor requires to operate from fully closed to fully open. <b>Note:</b> This item is only available when the Mix 1 Mode setting is set to floating action (FLt).
 <p>MIX 2 ADJUST TERM 1</p>	1 HRF1 2 HRF2 3 Fancoil 4 Fin-tube Convectore 5 Radiator 6 Baseboard Default = 1	InS Ad	<b>MIX 2 TERMINAL</b> <a href="#">SECTION B</a> The type of heating terminal units that are being used in mix 2 zones. <b>Note:</b> This item is only available when the tN4 DIP switch is set to Mix 2.
 <p>MIX 2 ADJUST 70<sup>°F</sup> INDR</p>	40 to 100 <sup>°F</sup> (4.5 to 38.0 <sup>°C</sup> ) Default = 70 <sup>°F</sup> (21.0 <sup>°C</sup> )	Ad	<b>MIX 2 INDOOR</b> <a href="#">SECTION B</a> The design indoor air temperature used in the heat loss calculation for mix 2 zones. Typically set to 70 <sup>°F</sup> (21.0 <sup>°C</sup> ). <b>Note:</b> This item is only available when the tN4 DIP switch is set to Mix 2.
 <p>MIX 2 ADJUST DSGN 120<sup>°F</sup></p>	70 to 220 <sup>°F</sup> (21.0 to 104.5 <sup>°C</sup> ) Default = 120 <sup>°F</sup> (49.0 <sup>°C</sup> )	InS Ad	<b>MIX 2 DESIGN</b> <a href="#">SECTION B</a> The supply water temperature required for the mix 2 zones on the typical coldest day of the year. <b>Note:</b> This item is only available when the tN4 DIP switch is set to Mix 2.
 <p>MIX 2 ADJUST MIN OFF</p>	OFF, 40 to 150 <sup>°F</sup> (OFF, 4.5 to 65.5 <sup>°C</sup> ) Default = OFF	Ad	<b>MIX 2 MINIMUM</b> <a href="#">SECTION G</a> The minimum allowed mix 2 target temperature. <b>Note:</b> This item is only available when the tN4 DIP switch is set to Mix 2.
 <p>MIX 2 ADJUST MAX 140<sup>°F</sup></p>	80 to 220 <sup>°F</sup> (26.5 to 104.5 <sup>°C</sup> ) Default = 140 <sup>°F</sup> (60.0 <sup>°C</sup> )	Ad	<b>MIX 2 MAXIMUM</b> <a href="#">SECTION G</a> The maximum allowed mix 2 target temperature. <b>Note:</b> This item is only available when the tN4 DIP switch is set to Mix 2.
 <p>MIX 2 ADJUST 105<sub>sec</sub> MOTR</p>	30 to 230 seconds Default = 105	Ad	<b>MIX 2 MOTOR</b> <a href="#">SECTION G</a> The time that the mix 2 actuating motor requires to operate from fully closed to fully open. <b>Note:</b> This item is only available when the tN4 DIP switch is set to Mix 2. Availability also depends on the type of mixing module being used.
 <p>BOIL ADJUST TERM 4</p>	1 HRF1 2 HRF2 3 Fancoil 4 Fin-tube Convectore 5 Radiator 6 Baseboard Default = 4	InS Ad	<b>BOILER TERMINAL</b> <a href="#">SECTION B</a> The type of heating terminal units that are being used in boiler zones. <b>Note:</b> This item is only available when the Boiler Sensor Sup / Ret DIP switch is set to Sup and the tN4 DIP switch is set to Boiler.

Continued on next page.

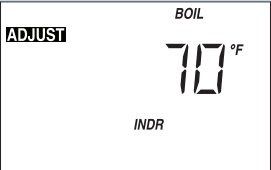
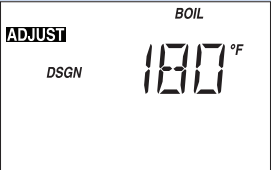
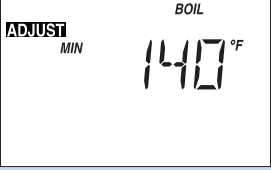
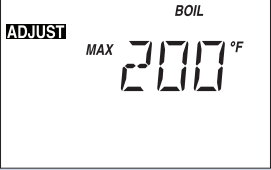
## Adjust Menu (3 of 5)

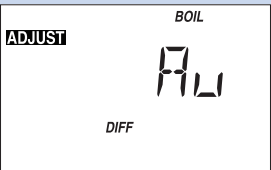
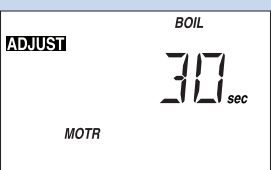
Item Field	Range	Access	Description
 <p>ADJUST INDR 70°F</p>	<p>40 to 100°F (4.5 to 38.0°C) Default = 70°F (21.0°C)</p>	Ad	<p><b>BOILER INDOOR</b> <a href="#">SECTION B</a></p> <p>The design indoor air temperature used in the heat loss calculation for the boiler zones. Typically set to 70°F (21.0°C).</p> <p><b>Note:</b> This item is only available when the Boiler Sensor Sup / Ret DIP switch is set to Sup and the tN4 DIP switch is set to Boiler.</p>
 <p>ADJUST DSGN 180°F</p>	<p>70 to 220°F (21.0 to 104.5°C) Default = 180°F (82.0°C)</p>	InS Ad	<p><b>BOILER DESIGN</b> <a href="#">SECTION B</a></p> <p>The supply water temperature required for boiler zones on the typical coldest day of the year.</p> <p><b>Note:</b> This item is only available when the Boiler Sensor Sup / Ret DIP switch is set to Sup and the tN4 DIP switch is set to Boiler.</p>
 <p>ADJUST MIN 140°F</p>	<p>OFF, 80 to 180°F (OFF, 26.5 to 82.0°C) Default = 140°F (60.0°C)</p>	InS Ad	<p><b>BOILER MINIMUM</b> <a href="#">SECTION C</a></p> <p>The minimum allowed boiler target temperature and boiler return protection temperature. Check the boiler manufacturer's manual for recommend supply water temperatures.</p>
 <p>ADJUST MAX 200°F</p>	<p>120 to 225°F, OFF (49.0 to 107.0°C, OFF) Default = 200°F (93.5°C)</p>	Ad	<p><b>BOILER MAXIMUM</b> <a href="#">SECTION C</a></p> <p>The maximum allowed boiler target temperature.</p> <p><b>Note:</b> This item is only available when the Boiler Sensor Sup / Ret DIP switch is set to Sup and the tekmar stager DIP switch is set to OFF.</p>
 <p>ADJUST F DLY 0:10</p>	<p>0:00 to 3:00 min Default = 0:10 min</p>	Ad	<p><b>FIRE DELAY</b> <a href="#">SECTION C</a></p> <p>The time delay the control can expect between the time that the relay contact closes to fire the boiler and when the burner actually fires.</p> <p><b>Note:</b> This item is only available when the Boiler Sensor Sup / Ret DIP switch is set to Sup and the tekmar stager DIP switch is set to OFF.</p>
 <p>ADJUST DIFF Au</p>	<p>Au, 2 to 42°F (Au, 1 to 23.5°C) Default = Au</p>	Ad	<p><b>BOILER DIFFERENTIAL</b> <a href="#">SECTION C</a></p> <p>The temperature differential that the control is to use when it is operating the boiler.</p> <p><b>Note:</b> This item is only available when the Boiler Sensor Sup / Ret DIP switch is set to Sup and the tekmar stager DIP switch is set to OFF.</p>
 <p>ADJUST MOTR 30 sec</p>	<p>10 to 230 seconds Default = 30 seconds</p>	Ad	<p><b>BOILER MOTOR</b> <a href="#">SECTION C</a></p> <p>The amount of time required for the modulating actuating motor to fully open the gas valve or operate the fan speed from a stopped position to full speed on a modulating boiler.</p> <p><b>Note:</b> This item is only available when the Boiler Sensor Sup / Ret DIP switch is set to Sup, the Boiler On-Off / Mod DIP switch is set to Mod and the tekmar stager DIP switch is set to OFF.</p>

ADJUST MENU

Continued on next page.

## Adjust Menu (4 of 5)

### ADJUST MENU

Item Field	Range	Access	Description
<p>ADJUST MIN MOD 0%</p>	0 to 50% Default = 0%	Ad	<b>MINIMUM MODULATION</b> <a href="#">SECTION C</a> The minimum percent modulation of the burner. <b>Note:</b> This item is only available when the Boiler Sensor Sup / Ret DIP switch is set to Sup, the Boiler On-Off / Mod DIP switch is set to Mod, and the tekmar stager DIP switch is set to OFF.
<p>ADJUST MAX MOD 100%</p>	50 to 100% Default = 100%	Ad	<b>MAXIMUM MODULATION</b> <a href="#">SECTION C</a> The maximum percent modulation of the burner. <b>Note:</b> This item is only available when the Boiler Sensor Sup / Ret DIP switch is set to Sup, the Boiler On-Off / Mod DIP switch is set to Mod, and the tekmar stager DIP switch is set to OFF.
<p>ADJUST CYC Au</p>	Au, 5 to 30 min Default = Au	Ad	<b>CYCLE LENGTH</b> The cycle length to which all tN4 devices will synchronize.
<p>ADJUST SCHED OFF</p>	OFF, Mb1, Mb2, Mb3, Mb4 Default = OFF	InS Ad	<b>SCHEDULE</b> Selects which network setback schedule the control will follow.
<p>ADJUST DHW MODE 1</p>	OFF, 1 (parallel, no priority) 2 (parallel, priority) 3 (pri-sec, no priority) 4 (pri-sec, priority) Default = 1	InS Ad	<b>DHW MODE</b> <a href="#">SECTION H</a> Selects the DHW mode of operation. This determines the operation of the primary pump in combination with the DHW pump and whether or not DHW priority is required.
<p>ADJUST DHW XCHG Occ 180°F</p>	100 to 220°F (38.0 to 104.5°C) Default = 180°F (82.0°C)	Ad	<b>DHW EXCHANGE OCCUPIED</b> <a href="#">SECTION H</a> The minimum boiler target temperature to the DHW heat exchanger during the Wake and Occupied periods. <b>Note:</b> This item is only available when DHW Mode is set 1 through 4.
<p>ADJUST DHW XCHG UnOcc OFF</p>	OFF, ON Default = OFF	Ad	<b>DHW EXCHANGE UNOCCUPIED</b> <a href="#">SECTION H</a> Selects whether the control should respond to DHW demands during the Sleep and Unoccupied periods. This item is only available when DHW Mode is set 1 through 4 and a network setback schedule is selected.
<p>ADJUST DHW MODE SETP 1</p>	OFF, 1 (parallel, no priority) 2 (parallel, priority) 3 (pri-sec, no priority) 4 (pri-sec, priority) Default = 1	Ad	<b>SETPOINT MODE</b> <a href="#">SECTION J</a> Selects the Setpoint mode of operation. This determines the operation of the primary pump.

Continued on next page.

## Adjust Menu (5 of 5)

### ADJUST MENU

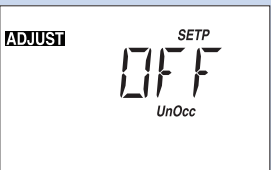
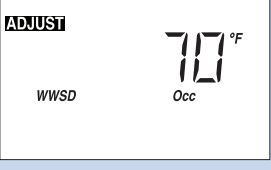
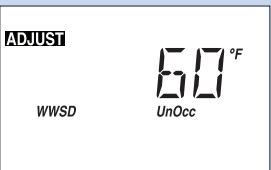
Item Field	Range	Access	Description
 <p>ADJUST SETP 180 °F Occ</p>	<p>60 to 220 °F (15.5 to 104.5 °C) Default = 180 °F (82.0 °C)</p>	Ad	<p><b>SETPOINT OCCUPIED</b> <i>SECTION J</i></p> <p>The minimum boiler target temperature when a setpoint demand is present during the Wake and Occupied periods.</p> <p><b>Note:</b> This item is only available when Setpoint Mode is set 1 through 4.</p>
 <p>ADJUST SETP OFF UnOcc</p>	<p>OFF, ON Default = OFF</p>	Ad	<p><b>SETPOINT UNOCCUPIED</b> <i>SECTION J</i></p> <p>Selects whether or not a Setpoint demand will be responded to during the Sleep and Unoccupied periods.</p> <p><b>Note:</b> This item is only available when Setpoint Mode is set 1 through 4 and a network setback schedule is selected.</p>
 <p>ADJUST WWSD 70 °F Occ</p>	<p>40 to 100 °F, OFF (4.5 to 38.0 °C, OFF) Default = 70 °F (21.0 °C)</p>	InS Ad	<p><b>WWSD OCCUPIED</b> <i>SECTION B</i></p> <p>The system's warm weather shut down temperature during the Wake and Occupied periods.</p>
 <p>ADJUST WWSD 60 °F UnOcc</p>	<p>40 to 100 °F, OFF (4.5 to 38.0 °C, OFF) Default = 60 °F (15.5 °C)</p>	Ad	<p><b>WWSD UNOCCUPIED</b> <i>SECTION B</i></p> <p>The system's warm weather shut down temperature during the Sleep and Unoccupied period.</p> <p><b>Note:</b> This item is only available when the Schedule is not set to OFF.</p>

After the last item, the control returns to the first item in the menu.

## Misc (Miscellaneous) Menu (1 of 1)

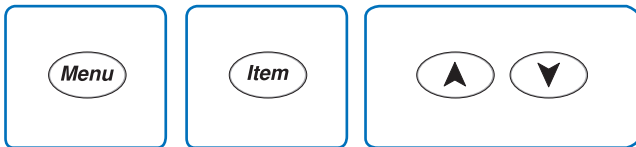

The Miscellaneous Menu Items set control and display options such as access level and temperature units.

MISC MENU

Item Field	Range	Access	Description
MISC 175 <sup>ACC</sup>	InS (Installer) Ad (Advanced)	InS Ad	<b>ACCESS LEVEL</b> The access level of the control. The access column shows which items are visible in each access level. <b>Note:</b> This item is only available when the Lock / Unlock DIP switch is set to Unlock.
MISC °F	°F, °C Default = °F	InS Ad	<b>UNITS</b> Select temperature units between Fahrenheit and Celsius.
MISC DEV 1 ⇌	0 to 24	Ad	<b>BOILER BUS DEVICES</b> Displays the number of devices on the Boiler Bus. <b>Note:</b> This item is only available when the tN4 Boil / Mix 2 DIP switch is set to Boil.
MISC DEV 1 ⇌	0 to 24	Ad	<b>BUS 1 DEVICES</b> Displays the number of devices on Bus 1.
MISC DEV 2 ⇌	0 to 24	Ad	<b>BUS 2 DEVICES</b> Displays the number of devices on Bus 2. <b>Note:</b> This item is only available when the tN4 Boil / Mix 2 DIP switch is set to Mix 2.
MISC DFLT OFF	OFF, SEL	Ad	<b>FACTORY DEFAULT</b> Loads the factory defaults when the Up and Down buttons are held down for 1 second.
MISC TYPE 422	422	InS Ad	<b>TYPE</b> Displays the type number of this product. Hold the UP button to display the software version.

• After the last item, the control returns to the first item in the menu.

# Testing the Control

The control has a built-in test routine that tests the main control functions. The control continually monitors the sensors and displays an error message whenever a fault is found. The individual outputs and relays are tested using a test sequence.

## Test Sequence

Each step in the test sequence lasts 10 seconds.

- Start the test sequence by pressing the Test button.
- Pause the test sequence by pressing the Test button again. To advance to the next step, press the Test button again.
- If the test sequence is paused for more than five minutes, the control exits the entire test routine.
- To advance to a particular step, repeatedly press and release the Test button to display the appropriate device.

### HAZARD

Access to the Test button requires the removal of the front cover and exposes hazardous voltage while the control is powered. Only trained, qualified and competent personnel should operate the Test button.



- Step 1** The Mix 1 device ramps up to 100% over 10 seconds or according to the motor speed setting.
- Step 2** The Mix 1 device ramps down to 0% over 10 seconds or according to the motor speed setting.
- Step 3** The Mixing 1 pump turns on for 10 seconds then shuts off.

IF the tN4 DIP switch is set to Mix 2:

- Step 4** The Mix 2 device ramps up to 100% over 10 seconds or according to the motor speed setting.
- Step 5** The Mix 2 device ramps down to 0% over 10 seconds or according to the motor speed setting.
- Step 6** The Mixing 2 pump on the mixing module turns on for 10 seconds then shuts off.

- Step 7** The primary pump turns on and remains on for the rest of the test sequence.
- Step 8** The boiler contact is closed to fire an on-off boiler for 10 seconds or enable a modulating boiler.

IF the On-Off / Modulating DIP switch is set to Modulating or the tekmar Stager / Off DIP switch is set to tekmar Stager:

- Step 9** When a demand is present, the modulation output ramps up to 100%.
- Step 10** When a demand is present, the modulation output ramps down to 0%.

The boiler contact is opened and the boiler is shut off.

- Step 11** If DHW MODE is set to 1 or 2, the primary pump is shut off and the DHW Pump contact is closed.  
If DHW MODE is set to 3 or 4, the primary pump stays on and the DHW Pump contact is closed.  
The control exits the test sequence.

If a device fails to operate during the test sequence, refer to the W422 Wiring Brochure to check the operation of the control. If the control works properly, refer to any troubleshooting information supplied by the equipment manufacturer.

## Max Heat

The control has a function called Max Heat. In this mode, the control turns on and operates the system up to the maximum set temperatures as long as there is a demand for heat. tN4 thermostats operate to meet the occupied setting +5°F (3°C). The control operates in this mode for up to 24 hours or until the Test button is pressed. Use this mode to run the circulators during system start-up to purge air from the piping.

- The Mix 1, Mix 2 and Mix 3 Maximum settings are available in the Adjust Menu when in Max Heat.

### HAZARD

Access to the Test button requires the removal of the front cover and exposes hazardous voltage while the control is powered. Only trained, qualified and competent personnel should operate the Test button.



To enable Max Heat:

Press and hold the Test button for more than 3 seconds and less than 6 seconds.

If there is a demand for heat, the 'TEST' and 'MAX' segments are displayed on screen and the control will turn on all outputs for up to 24 hours.

If there is no demand for heat, the 'TEST' and 'MAX' segments are still displayed but no outputs are turned on until there is a demand for heat present.

To Cancel Max Heat:

Press the Test button to cancel Max Heat manually or wait 24 hours and the control will automatically leave the Max Heat mode.

## Zone Test

In Zone Test mode, each tN4 device is individually turned on one at a time. The control tests each zone for up to 5 minutes of no button activity. Use this feature to purge air out of each zone and assist in troubleshooting.

### HAZARD

Access to the Test button requires the removal of the front cover and exposes hazardous voltage while the control is powered. Only trained, qualified and competent personnel should operate the Test button.



To enable Zone Test:

- Press and hold the Test button for more than 6 seconds. The control displays ZN TEST OFF.
- Press the Up button to change the display to ZN TEST ON. After 3 seconds, the boiler, all pumps, and the mixing valves are shut off.
- The control operates stage one of the tN4 device with the lowest address number. Device number one of the boiler bus (b:01) has the lowest address number and device 24 of bus 3 (3:24) has the highest address number. All other tN4 zones are shut off.
- Pressing the Up button will turn off stage 1, and turn on stage 2 of the same device (if that device has a second stage) or turn on stage 1 of the device with the next lowest address. The Down button can be pressed to move to a device with a lower address number. The Up and Down buttons will only move through devices on the same bus.
- Press the Item button to switch busses. The Up and Down buttons can then be used to move through the devices and the heating stages of each device on the next bus.
- To cancel the Zone Test, press the Test button. Once the Zone Test ends or is cancelled, the control resumes normal operation.

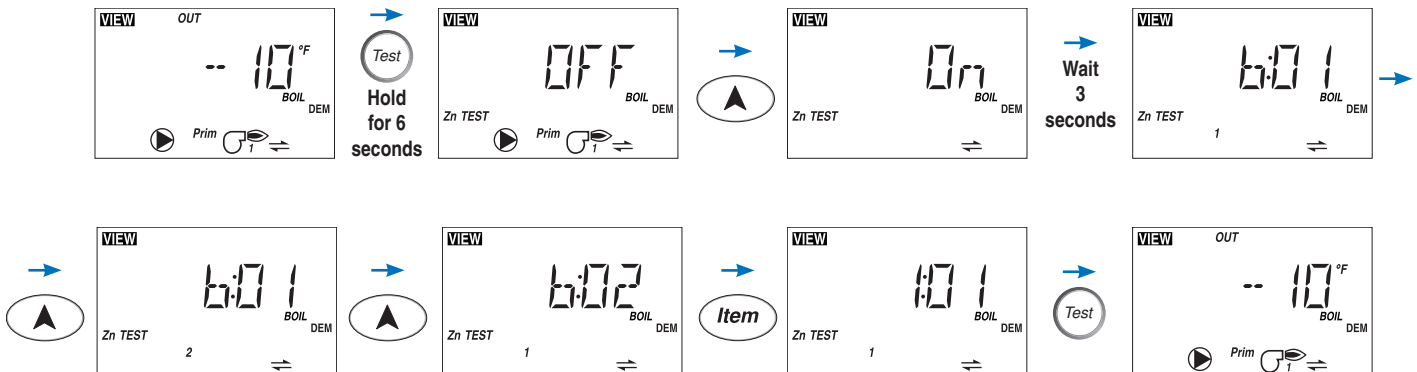

# Sequence of Operation

## tekmarNet®4 Communication

## Section A

tekmarNet®4 (tN4) communicates between tN4 devices (thermostats, Reset Module and Expansion Modules). Each tN4 device is connected to a tN4 communication bus using two wires. Each tN4 bus adjusts a single water temperature in the system using indoor temperature feedback. The Universal Reset Module 422 allows for two tN4 buses. This allows you to control a system with two separate water temperatures.

A system that has more than one tN4 bus is referred to as a tN4 network.

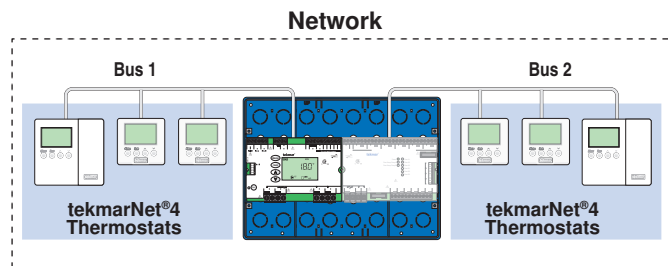

## Outdoor Reset Module

The Universal Reset Module 422 is the system control for a hydronic heating system. The 422 operates a single heat source such as a boiler, one or two mixing devices, a domestic hot water tank, and responds to other heating requirements such as pool heating and snow melting. The 422 also coordinates and optimizes the operation of all the tN4 thermostats.

## tN4 Thermostat

The tN4 thermostat operates heating, cooling, and or ventilation equipment for a zone. Several tN4 thermostats may work in a group when operating a cooling system. Up to 24 tN4 thermostats can connect to a single tN4 bus.

## Outdoor Reset

## Section B

In a heating system, the rate of heat supplied to the building must equal the rate of which heat is lost. If the two rates are not equal, the building will either cool off or over heat.

The rate of building heat loss depends mostly on the outdoor temperature. Outdoor Reset allows a hot water heating system to increase the water temperature, adding heat to the building, as the outdoor temperature drops. The rate at which the water temperature is changed is defined by the characterized heating curve.

## Characterized Heating Curves

A characterized heating curve determines the amount the supply water temperature is raised for every 1° drop in outdoor air temperature. There is a characterized heating curve for each tN4 communication bus.

The characterized heating curve takes into account the type of terminal unit that the system is using. Since different types of heating terminal units transfer heat to a space using different proportions of radiation, convection and conduction, the supply water temperature must be controlled differently. Each tN4 bus is assigned a terminal unit setting that the control uses to vary the supply water temperature to suit to the terminal unit used. This improves the control of the air temperature in the building.

## Indoor Temperature Feedback

Most buildings have internal heat gains due to people, passive solar heating and mechanical or electrical equipment. Likewise, wind loads cause a building to lose heat faster than during design conditions. If only the outdoor temperature is measured, the control cannot compensate for these internal heat gains or losses and the building may over or under heat. In order to maintain the most comfortable temperature, the control uses indoor temperature feedback from tN4 thermostats in order to adjust the water temperature on each tN4 bus on a continual basis.



## Terminal Unit

---

There is a terminal unit setting for each tN4 bus. The Terminal Unit setting is found in the Adjust menu.

### Hydronic Radiant Floor (1)

Terminal type 1 is a heavy, or high mass, hydronic radiant floor system. This type of a hydronic radiant floor is embedded in either a thick concrete or gypsum pour. This heating system has a large thermal mass and is slow acting.

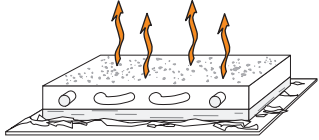

### Hydronic Radiant Floor (2)

Terminal type 2 is a light, or low mass, hydronic radiant floor system. Most commonly, this type of radiant heating system is either attached to the bottom of a wood sub floor, suspended in the joist space, or sandwiched between the subfloor and the surface. This type of radiant system has a relatively low thermal mass and responds faster than a high mass system.

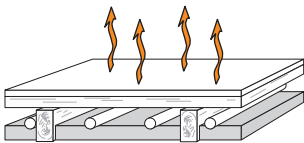

### Fancoil (3)

Terminal type 3 is a fancoil terminal unit or air handling unit (AHU) consisting of a hydronic heating coil and either a fan or blower. Air is forced across the coil at a constant velocity by the fan or blower and is then delivered into the building space.

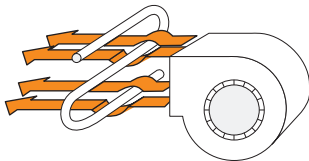

### Fin-tube Convector (4)

Terminal type 4 is a convector terminal unit is made up of a heating element with fins on it. This type of terminal unit relies on the natural convection of air across the heating element to deliver heated air into the space. The amount of natural convection is dependant on the supply water temperature to the heating element and the room air temperature.

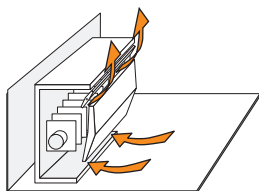

### Radiator (5)

Terminal type 5 is a radiator terminal unit has a large heated surface that is exposed to the room. A radiator provides heat to the room through radiant heat transfer and natural convection.

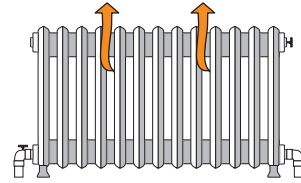

### Baseboard (6)

Terminal type 6 is a baseboard terminal unit is similar to a radiator, but has a low profile and is installed at the base of the wall. The proportion of heat transferred by radiation from a baseboard is greater than that from a fin-tube convector.

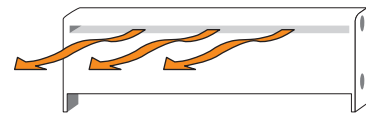

## Outdoor Design Temperature

---

The outdoor design temperature is typically the coldest outdoor air temperature of the year. This temperature is used when doing the heat loss calculations for the building and is used to size the heating system equipment. If a cold outdoor design temperature is selected, the supply water temperature rises gradually as the outdoor temperature drops. If a warm outdoor design temperature is selected, the supply water temperature rises rapidly as the outdoor temperature drops.

The outdoor design setting is found in the Adjust menu.

## Warm Weather Shut Down (WWSD)

---

The Warm Weather Shut Down is the outdoor temperature at which hydronic heating is no longer required. The control closes mixing valves and variable speed pumps are not operated. The boiler operates only when a Domestic Hot Water (DHW) Demand or a Setpoint Demand is present.

The WWSD setting is found in the Adjust menu.

## Boiler Outdoor Reset

There is a water temperature and therefore a characterized heating curve for each communication bus. When using boiler temperature water to heat zones, the installer will be required to set a boiler characterized heating curve. This requires the tN4 DIP switch to be set to Boiler and the Boiler Sensor DIP switch set to Supply.

### Boiler Terminal Unit Defaults

When a terminal unit is selected for boiler zones, the control loads default values for the boiler design, boiler maximum supply, and boiler minimum supply temperatures. The factory defaults can be changed to better match the installed system. Locate the Boiler Terminal Unit setting in the Adjust menu.

**Boiler Characterized Heating Curve**

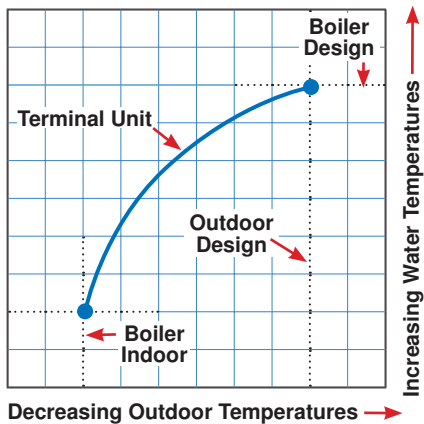

Terminal Unit	BOIL DSGN	BOIL MAX	BOIL MIN
High Mass Radiant (1)	120°F (49°C)	140°F (60°C)	OFF
Low Mass Radiant (2)	140°F (60°C)	160°F (71°C)	OFF
Fancoil (3)	190°F (88°C)	210°F (99°C)	140°F (60°C)
Fin-Tube Convactor (4)	180°F (82°C)	200°F (93°C)	140°F (60°C)
Radiator (5)	160°F (71°C)	180°F (82°C)	140°F (60°C)
Baseboard (6)	150°F (76°C)	170°F (77°C)	140°F (60°C)

### Boiler Indoor Design

The boiler indoor design temperature is the indoor temperature the heating designer chose while calculating the heat loss for the boiler water heated zones. This temperature is typically 70°F (21.0°C). This setting establishes the beginning of the boiler characterized heating curve.

- Locate the Boiler Indoor Design setting in the Adjust menu.

### Boiler Design Temperature

The boiler design supply temperature is the boiler water temperature required to heat the zones on the typical coldest day of the year.

- Locate the Boiler Design setting in the Adjust menu.

## Mix 1 and Mix 2 Outdoor Reset

Each tN4 communication bus operates on a separate water temperature. Therefore a separate characterized heating curve is required for Mix 1 and, if the tN4 DIP switch is selected to Mix 2, for mix 2 as well.

### Mix 1 and 2 Terminal Unit Defaults

When a terminal unit is selected for Mix 1 (or Mix 2), the control loads default values for the mix design, mix maximum supply, and mix minimum supply temperatures. The factory defaults can be changed to better match the installed system.

- Locate the Mix 1 and Mix 2 terminal unit settings in the Adjust menu.

**Mix Characterized Heating Curve**

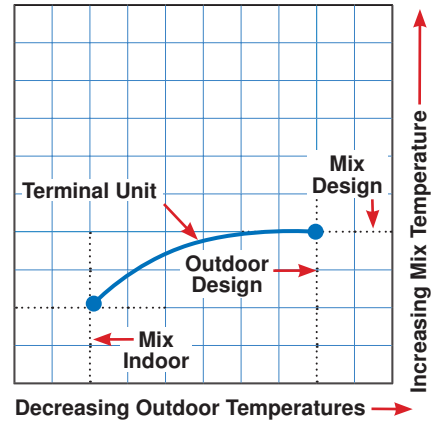

Terminal Unit	MIX DSGN	MIX MAX	MIX MIN
High Mass Radiant (1)	120°F (49°C)	140°F (60°C)	OFF
Low Mass Radiant (2)	140°F (60°C)	160°F (71°C)	OFF
Fancoil (3)	190°F (88°C)	210°F (99°C)	100°F (38°C)
Fin-Tube Convactor (4)	180°F (82°C)	200°F (93°C)	OFF
Radiator (5)	160°F (71°C)	180°F (82°C)	OFF
Baseboard (6)	150°F (76°C)	170°F (77°C)	OFF

### Mix 1 and Mix 2 Indoor Design

The Mix 1 (or Mix 2) indoor design temperature is the indoor temperature the heating designer picked while calculating the heat loss for the building for the Mix 1 (or Mix 2) water heated zones. This temperature is typically 70°F (21.0°C). This setting establishes the beginning of the Mix 1 (or Mix 2) characterized heating curve.

- Locate the Mix 1 and Mix 2 Indoor Design settings in the Adjust menu.

### Mix 1 and Mix 2 Design Temperature

The Mix 1 (or Mix 2) design supply temperature is the mix supply water temperature required to heat the zones when the outdoor temperature is as cold as the outdoor design temperature.

- Locate the Mix 1 and Mix 2 Design settings in the Adjust menu.

The 422 is able to operate a single, hot water, on-off or modulating boiler as a heat source. For proper operation of the boiler, the 422 must be the only control that determines when the boiler is to fire. In this case, the boiler sensor should be located on the boiler supply pipe and the Boiler Sensor DIP switch is set to Supply.

**\*Important note:** The boiler operator, also known as an aquastat, remains in the burner circuit and acts as a secondary upper limit on the boiler temperature. The boiler operator temperature setting must be adjusted above the 422's Boiler Maximum setting in order to prevent short cycling of the boiler burner.

**Boiler Target Temperature**

The boiler target temperature is determined by connected tN4 devices or by a DHW or Setpoint demand received by the control. The tN4 devices determine the highest water temperature required and then, requests this temperature on the tN4 boiler bus. The temperature request creates a Boiler Demand and this is indicated on the display. A DHW demand and a Setpoint demand have temperature settings to which the boilers are operated to meet and are able to override the tN4 bus temperature if required.

The control displays the temperature that it is currently trying to maintain as the boiler supply temperature in the View menu. If the control does not presently have a requirement for heat, it does not show a boiler target temperature. Instead, “- - -” is displayed in the LCD.

**Operation of the tN4 Boiler / Mix 2 Bus**

The 422 has two available tN4 communication buses. One bus is dedicated for a mix water temperature and is known as Mix 1. The second bus can operate at either boiler water temperatures or at mixing water temperatures. The tN4 Boiler / Mix 2 DIP switch affects the operation of the boiler target temperature. The mix 1 bus is connected to a Zone manager via the plug on the underside of the board. The boiler / Mix 2 bus is connected to a Zone manager via terminals 59 and 60.

**Boiler Temperature Zones**

When the control is to operate boiler temperature zones, the Boiler / Mix 2 tN4 DIP switch must be set to Boiler. The Boiler Bus then operates the boiler directly in order to heat the zones operated by tN4 thermostats connected to this bus. The boiler water temperature target will be determined based upon boiler outdoor reset and indoor feedback from the tN4 thermostats.

**Mix Temperature Zones**

When the control is to operate mix temperature zones, the Boiler / Mix 2 tN4 DIP switch must be set to Mix 2. The Mix 2 Bus uses a second mixing device to maintain a mix 2 water temperature target. The boiler target temperature is determined using Boiler Load Reset, in which the boiler water temperature is maintained at the lowest possible temperature that satisfies the heating load of the two mixing devices. See Mixing Operation for more information.

**Boiler Minimum**

The boiler minimum is the lowest temperature that the control is allowed to use as a boiler target temperature. During mild conditions, if the control calculates a boiler target temperature that is below the Boiler Minimum setting, the boiler target temperature is adjusted to at least the Boiler Minimum setting. During this condition, if the boiler is operating, the minimum segment is turned on in the display when viewing either the boiler supply temperature or the boiler target temperature. Set the Boiler Minimum setting to the boiler manufacturer's recommended temperature.

- Locate the Boiler Minimum setting in the Adjust menu.

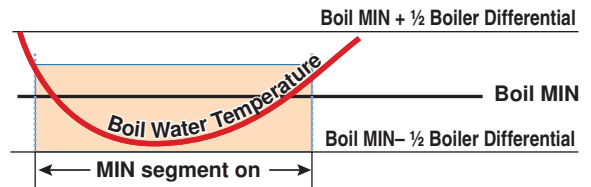

**Boiler Maximum**

The boiler maximum is the highest temperature that the control is allowed to use as a boiler target temperature. If the control does target the Boiler Maximum setting, and the boiler temperature is near the boiler maximum temperature, the maximum segment will be displayed in the LCD while either the boiler target temperature or the boiler temperature is being viewed. At no time does the control operate the boiler above 248 °F (120.0 °C).

- Locate the Boiler Maximum setting in the Adjust menu.

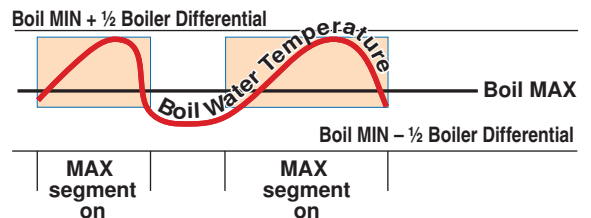

**Fire Delay**

The Fire Delay is the time delay that occurs between the time that the control closes the boiler contact to fire the boiler and when the burner fires.

- Locate the Fire Delay setting in the Adjust menu.

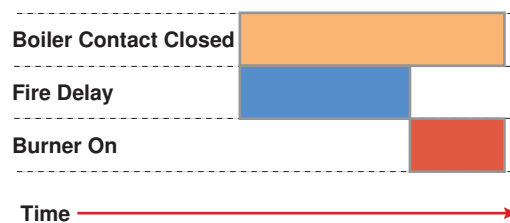

## On-Off Boiler Operation

If the heat source is an On-Off Boiler, the Boil On-Off / Mod DIP switch must be set to On-Off.

### Differential

An on / off heat source must be operated with a differential in order to prevent short cycling. With the control, either a fixed or an auto differential may be selected. The boiler differential is divided around the boiler target temperature. The boiler contact closes when the supply water temperature is 1/2 of the differential setting below the boiler target temperature. As the supply temperature reaches 1/2 of the differential above the boiler target temperature, the boiler is shut off.

- Locate the Boiler Differential setting in the Adjust menu.

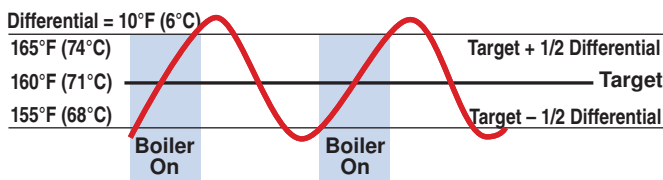

### Fixed Differential

If the user desires to have a fixed differential, this is set using the Boiler Differential setting in the Adjust menu.

### Auto Differential

In order to decrease temperature swings and increase boiler efficiency, the Auto Differential feature automatically changes the on / off differential of the boiler based on the heating load. As the load increases, the differential will decrease to minimize temperature swings. As the load decreases, the differential will increase to prevent short cycling.

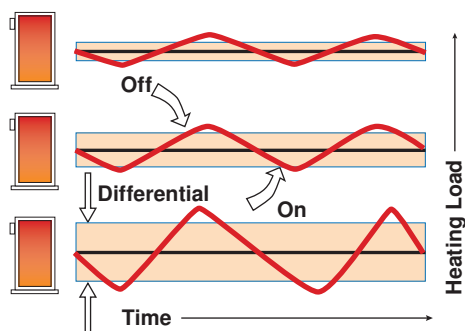

## Modulating Boiler Operation

The 422 can operate a single hot-water modulating boiler. This requires the use of the Mod (dc) output on the 422.

To operate a modulating boiler, the Boil On-Off / Mod DIP switch must be set to Mod. The control operates the boiler by first switching the boiler contact to allow the modulating boiler to go through the ignition sequence (the boiler contact may not be required on all modulating boilers). A 0-10 V (dc) analog signal is used to modulate the boiler firing rate from the Minimum Modulation setting using Proportional, Integral and Derivative (PID) logic in order to satisfy the boiler target temperature.

A modulating boiler requires all the same settings as an on-off boiler in addition to the settings below.

### Modulating Boiler Differential

A modulating boiler must be operated with a differential while operating in low fire. The boiler differential is divided around the boiler target temperature. The boiler burner ignites at low fire when the supply water temperature is 1/2 of the Boiler Differential setting below the boiler target temperature. The boiler is shut off in low fire as the supply temperature reaches at least 1/2 of the differential above the boiler target temperature. With the control, either a fixed or an auto differential may be selected.

When the boiler is modulating above low fire, the differential does not apply. Instead, the modulation output signal is determined using Proportional, Integral and Derivative (PID) logic in order to satisfy the boiler target temperature.

### Boiler Motor Speed

The Boiler Motor Speed is the amount of time the boiler requires to go from 0% modulation to 100% modulation.

Gas valve actuating motors have a design time from fully closed to fully open which can be found in the manufacturer's manual. The Boiler Motor Speed should be set to this time.

The Boiler Motor Speed setting for a Variable Frequency Drive (VFD) is the amount of time required to go from a stopped position to 100% fan speed. Since a VFD has a very quick response rate, it may be necessary to increase the Motor Speed setting in order to increase the stability of the boiler modulation.

- Locate the Boiler Motor Speed setting in the Adjust menu.

### Minimum Modulation

The minimum modulation defines the minimum output signal from the control to the boiler burner. It is based on a percentage of the control's output signal range.

The Minimum Modulation default setting is 0%.

For boilers with electronic operators, the boiler's input signal range may not match the output signal range of the 422 control. The Minimum Modulation setting limits the control output range in order to match the boiler's input range.

- Locate the Minimum Modulation setting in the Adjust menu.

To calculate the Minimum Modulation, use the following formula:

#### For 0-10 V (dc):

$$\text{Minimum Modulation} = \frac{0 \text{ V (dc)} - \text{Boiler's Minimum Input Signal}}{0-10 \text{ V (dc)}} \times 100\%$$

#### Example:

A boiler requires a 1.8 V (dc) signal to fire the boiler at low fire. The boiler can be modulated to 10 V (dc) where it reaches high fire.

This means the boiler's input signal range is 1.8 to 10 V (dc). The 422 control has an output signal range of 0-10 V (dc).

To make the two signal ranges the same, the Minimum Modulation required is:

$$\text{Minimum Modulation} = \frac{0 \text{ V} - 1.8 \text{ V}}{0 \text{ V} - 10 \text{ V}} \times 100\% = 18\%$$

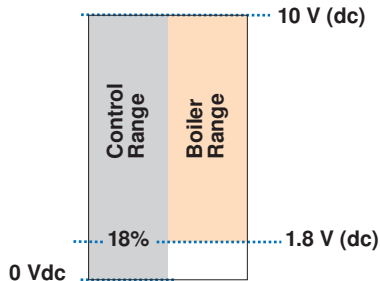

### Maximum Modulation

The maximum modulation defines the maximum output signal from the control to the boiler burner. It is based on a percentage of the control's output signal range.

The Maximum Modulation default setting is 100%.

For boilers with electronic operators, the boiler's input signal range may not match the output signal range of the 422 control. The Maximum Modulation setting limits the control output range in order to match the boiler's input range.

- Locate the Maximum Modulation setting in the Adjust menu.

To calculate the Maximum Modulation, use the following formula:

#### For 0-10 V (dc):

$$\text{Maximum Modulation} = \frac{0 \text{ V (dc)} - \text{Boiler's Maximum Input Signal}}{0-10 \text{ V (dc)}} \times 100\%$$

#### Example:

A boiler's input signal range is 2-9 V (dc). The 422 control has an output signal range of 0-10 V (dc).

To make the two signal ranges the same, the Maximum Modulation required is:

$$\text{Maximum Modulation} = \frac{0 \text{ V} - 9 \text{ V}}{0 \text{ V} - 10 \text{ V}} \times 100\% = 90\%$$

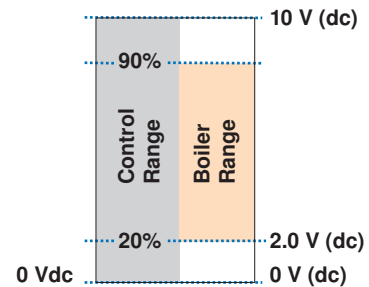

## tekmar Stager Operation

## Section D

In some cases, multiple boilers may be required. In these cases, the 422 allows for a connection to a tekmar Boiler Control 264, 265, or 268. The 422 uses the modulating output to provide a 0-10 V (dc) signal to the external input terminals on the Boiler Control. The 422 controls the Boiler Control target temperature by changing the voltage signal. The Boiler Control responds to the boiler target by staging the multiple boilers.

The following table can be used to convert a 0-10 V (dc) signal to a boiler target temperature:

To use the tekmar Staging operation, the following DIP switch settings are required:

1. Set the 422 Off/ tekmar Stager DIP switch to tekmar Stager.
2. Set the 422 Boil Sup / Ret DIP switch to Sup.
3. Set the 422 Boil On-Off / Mod DIP switch to Mod.

The 422 boiler sensor must be located on the supply pipe leading from the boilers. On the Boiler Control 264, 265, or 268, the External Input / Stand Alone DIP switch must be set to External Input. Any domestic hot water (DHW) demands or setpoint demands in the system must connect to the 422 in order to allow for DHW or setpoint priority.

Voltage (dc)	0	1	2	3	4	5	6	7	8	9	10
Boiler Target	Off	50°F (10°C)	68°F (20°C)	86°F (30°C)	103°F (40°C)	121°F (50°C)	139°F (60°C)	157°F (70°C)	174°F (80°C)	192°F (90°C)	210°F (99°C)

If the 422 is one of many controls that can call for heat to a single boiler or there is a boiler sequencer other than a tekmar Stager (Boiler Control 264, 265, 268), operating multiple boilers or multiple stages, then the boiler sensor must be located on the return pipe of the boiler(s).

When the sensor is located on the return, the 422 provides a boiler enable. The 422 no longer tries to control the boiler supply water temperature directly, but allows another operating control such as an aquastat to regulate the boiler supply temperature.

When there is a requirement for heat from the 422 mixing device(s), or a DHW Demand, or a Setpoint Demand is present, the 422 boiler contact closes to enable the boiler. The boiler contact remains closed until heat is no longer required.

When the boiler sensor is located on the boiler return, the control is able to provide boiler return protection through the use of a mixing device. This protects the boiler sustained flue gas condensation and thermal shock.

**\*Important note:** The tN4 DIP switch cannot be set to Boiler while the Boiler Sensor DIP switch is set to Return.

To operate the control without a boiler sensor and prevent the control from displaying an error message, set the boiler sensor DIP switch to Return and power up the control without the boiler sensor connected.

The control operation will be similar to that as having the boiler sensor on the return except that boiler return protection is no longer provided.

If the boiler temperature approaches the boiler minimum setting, the control can turn off certain high temperature zones in order to reduce the load on the boiler. This is known as Zone Load Shedding. Zones are shed in the following order:

1. The second stage of any 2-stage thermostats which have "BOIL" selected as their heat source in order of decreasing priority. Priority is determined by the address number of the thermostat (b:01 is the highest priority, 3:24 is the lowest priority).

2. The first stage of any thermostats on the boiler bus, again, in order of decreasing priority. The first stage of the highest priority thermostat (lowest address number) will not be shed unless there is also a setpoint or DHW call.

When the boiler supply temperature goes above the minimum setting, the control begins restoring the load by turning first stages back on in the reverse order that they were shed, followed by second stages in the reverse order that they were shed.

The 422 has two tN4 communication buses. The first bus is dedicated for a mix water temperature and is known as Mix 1. The second bus can be selected to be either boiler or mixing depending on the tN4 DIP switch position. When the tN4 DIP switch is set to Mixing, the second bus is known as Mix 2. Mix 2 requires that a Mixing Expansion Module be connected to the Mix 2 tN4 bus.

A Mixing Expansion Module is required in order to use the second mixing temperature. The Mixing Expansion Module operates at the percent output that the 422 determines is required.

Each of the following settings must be set for the Mix 1 bus and for the Mix 2 bus when the tN4 DIP switch is set to Mix 2.

### **Mix 1 Mode**

A mixing device allows the control to reduce the boiler water temperature down to a lower water temperature. A mixing device when used with a boiler sensor also allows the control to protect the boiler from sustained flue gas condensation and thermal shock.

The Mix 1 outputs are built-in to the 422. The type of mixing device for Mix 1 is selected using the Mix 1 Mode setting. The mixing devices that can be selected are variable speed injection (VAr) and floating action (FLt).

- Locate the Mix 1 Mode setting in the Adjust menu.

## Variable Speed Injection

A standard wet rotor circulator can be connected to the Variable Speed output on the control for Mix 1 and on a Mixing Module for Mix 2. The control increases or decreases the power output to the circulator when there is a requirement for mixing. The circulator speed varies to maintain the correct mixed supply water temperature at the mix supply sensor. For correct sizing and piping of the variable speed injection circulator, refer to essay E 021. A visual indication of the current variable speed output is displayed in the LCD in the form of a bar graph along with the Mix 1 or the Mix 2 segment to indicate which mixing device is being currently viewed.

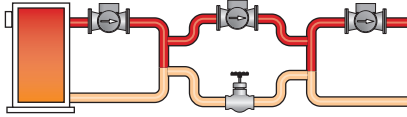

## Floating Action

A floating action actuator motor can be connected to the control (Mix 1) or a Mixing Module (Mix 2) on the Opn and Cls terminals. The control pulses the actuator motor open or close to maintain the correct supply water temperature at the mix supply sensor when there is a requirement for mixing. The mixing valve that the actuator is connected to can be either a 2-way, 3-way or 4-way valve. A visual indication as to whether the control is currently opening or closing the mixing valve is displayed in the LCD with the words OPN and CLS while viewing the Mix Supply or Mix Target temperatures. Also, a visual indication of the current position of the valve is displayed in the form of a bar graph along with the Mix 1 or the Mix 2 segment to indicate which mixing device is being currently viewed.

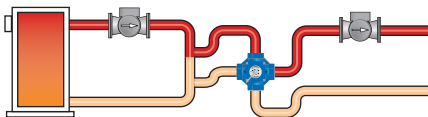

## Mix 1 and Mix 2 Minimum

The Mix 1 and Mix 2 Minimum settings are the lowest temperature that the control is allowed to use as a mix target temperature. During mild conditions, if the control calculates a mix target temperature that is below the mix minimum setting, the mix target temperature is adjusted to match the mix minimum setting. During this condition, if the mixing supply temperature is near the mix minimum setting, the Min segment turns on in the LCD when either the mix target temperature or the mix supply temperature is being viewed.

- Locate the Mix 1 and the Mix 2 Minimum settings in the Adjust menu.

## Mix 1 and Mix 2 Maximum

The Mix 1 Maximum and Mix 2 Maximum set the highest water temperature that the control is allowed to use as a mix target temperature. If the control does target the mix maximum setting, and the mix supply temperature is near the mix maximum temperature, the Max segment turns on in the LCD when either the mix target temperature or the mix supply temperature is viewed.

- Locate the Mix 1 and the Mix 2 Maximum settings in the Adjust menu.

## Boiler Minimum Protection

The control is capable of providing boiler protection from cold mixing system return water temperatures. If the boiler water temperature is cooler than the Boiler Minimum setting while the boiler is firing, the control reduces the output from the mixing devices. Both mixing outputs are reduced at the same rate. Reducing the mixing output limits the amount of cool return water to the boiler and allows the boiler water temperature to recover. This feature can only be used if the boiler sensor is on the supply or on the return but is not available when the boiler sensor is not present.

## Domestic Hot Water Temperature Operation

## Section H

### DHW Demand

A powered DHW Demand is required in order for the control to provide heat to the DHW system. A DHW aquastat or setpoint control is used as a switch in the DHW demand circuit. The control registers a DHW Demand when a voltage between 24 and 230 V (ac) is applied across the DHW Demand terminals (53 and 54).

Once the control detects a DHW demand, the DHW Demand segment turns on in the LCD.

### Boiler Target Temperature

The boiler target temperature is at least as hot as the DHW Exchange setting. The DHW demand overrides the boiler reset target temperature, except when the boiler reset target is higher than the DHW exchange setting.

- Locate the DHW Exchange setting in the Adjust menu.

### DHW During UnOccupied

The control has a DHW Exchange UnOccupied setting that allows the installer to select On or Off. When set to On, and the control receives a DHW Demand during an UnOccupied or Sleep period, the control continues operation of the DHW system as it would during the Occupied and Wake periods. When set to Off, the control can ignore a DHW Demand for the duration of the UnOccupied and Sleep periods.

## DHW Mode and Priority Operation

The control has four different settings available for DHW Mode that affect pump operation. The required DHW Mode setting will depend on the piping arrangement of the DHW tank and whether or not priority for DHW is necessary. DHW Priority stops or limits the delivery of heat to the building heating system while the DHW tank calls for heat. This allows for quick recovery of the DHW tank.

- Locate the DHW Mode setting in the Adjust menu.

### DHW MODE 1 - DHW in Parallel no Priority

When a DHW Demand is present, the DHW Pump contact closes. The primary pump (P1) does not turn on, but may operate based on either Boiler or Mixing requirements or a Setpoint Demand.

It is assumed that the DHW pump will provide adequate flow through the heat exchanger and the boiler.

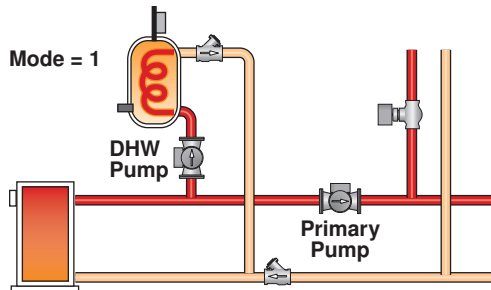

### DHW MODE 2 - DHW in Parallel with Priority

When a DHW Demand is present, the DHW Pump contact closes. The primary pump (P1) can operate when a boiler demand is present. If the boiler is unable to maintain the boiler target temperature, space heating zones are shut off sequentially using tN4 communication in order to provide priority to the DHW tank. This is known as zone load shedding.

It is assumed that the DHW pump will provide adequate flow through the heat exchanger and the boiler.

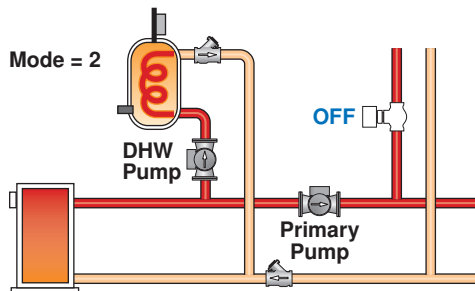

### DHW MODE 3 - DHW in Primary / Secondary no Priority

When a DHW Demand is present, the DHW Pump contact is closed and the primary pump (P1) is operated.

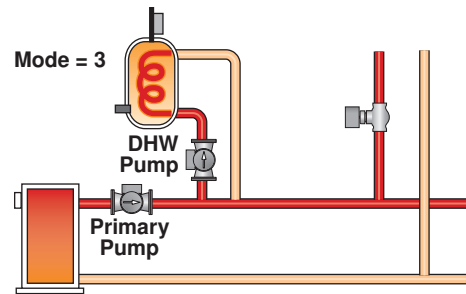

### DHW MODE 4 - DHW in Primary / Secondary with Priority

When a DHW Demand is present, the DHW Pump contact is closed and the primary pump (P1) is operated. Priority over space heating zones is achieved by shutting off the zone pumps or zone valves through tN4 communication. This is known as zone load shedding.

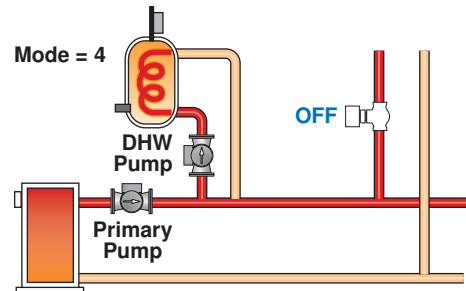

## DHW Priority Override

DHW Priority Override applies to DHW MODE 2 and 4. To prevent the building from cooling off too much or the possibility of a potential freeze up during DHW priority, the control limits the amount of time for DHW priority. As the outdoor air temperature becomes colder, the length of time that the control provides DHW priority is reduced. Once the allowed time for priority has elapsed, the control overrides the DHW priority and resumes space heating.

### DHW Priority Override Time

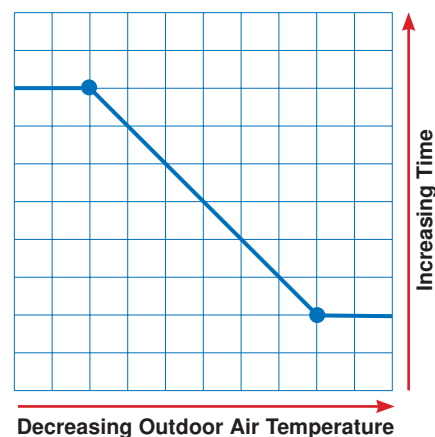



## Conditional DHW Priority

If the boiler supply temperature is maintained at or above the required temperature during DHW generation, this indicates that the boiler has enough capacity for DHW and possibly heating as well. As long as the boiler supply temperature is maintained near the target, DHW and heating occurs simultaneously.

## DHW Post Purge

After the DHW Demand is removed, the control performs a purge on the boiler. The control shuts off the boiler and continues to operate the DHW pump and the primary pump (P1) if applicable. This purges the residual heat from the boiler into the DHW tank. The control continues this purge for a maximum of four minutes or until the boiler supply water temperature drops 20°F (-6.5°C) below the boiler target temperature during the DHW operation. The control also stops the purge if the boiler supply temperature drops below the current boiler target temperature.

## DHW Mixing Purge

After DHW operation, the boiler is extremely hot. At the same time, the heating zones may have cooled off considerably after being off for a period of time. When restarting the heating system after a DHW demand with priority, the control shuts off the boiler and continues to operate the DHW pump while the primary pump is turned on. This allows some of the DHW return water to mix with the cool return water from the zones and temper the boiler return water.

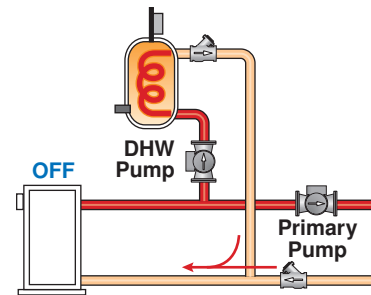

## DHW with Low Temperature Boilers

### Section I

If DHW heating is to be incorporated into a low temperature system such as a radiant floor heating system, a mixing device is often installed to isolate the high DHW supply temperature from the lower system temperature. If a mixing device is not installed, high temperature water could be supplied to the low temperature system while trying to satisfy the DHW demand. This may result in damage to the low temperature heating system.

The control is capable of providing DHW heating in such a system while minimizing the chance that the temperature in the heating system exceeds the design supply water temperature. In order to do this, the control must be set to DHW MODE 2 or DHW MODE 4 and Boil MIN must be set to OFF.

On a call for DHW, the control provides DHW priority by sending a message on the boiler temperature bus to the tN4 thermostats to shut off the heating zones for a period of time. The length of time is based on the outdoor air temperature as described in the DHW Priority Override section. However, if the DHW Demand is not satisfied within the allotted time, the boiler shuts off and the heat of the boiler is purged into the DHW tank. A DHW mixing purge occurs in order to reduce the boiler water temperature and once the boiler supply temperature is sufficiently reduced, the DHW Pump contact shuts off. The heating system zones are allowed to turn on for a period of time to prevent the building from cooling off. After a period of heating, and if the DHW Demand is still present, the control shuts off the heating system and provides heat to the DHW tank once again.

## Setpoint Temperature Operation

### Section J

### Setpoint

The control can operate to satisfy the requirements of a setpoint load in addition to a space heating load and a DHW load. A setpoint load overrides the current outdoor reset temperature and WWSD setting in order to provide heat to the setpoint load.

### Setpoint Demand

A Setpoint Demand is required in order for the control to provide heat to a setpoint load.

The control registers a setpoint demand when a voltage between 24 and 230 V (ac) is applied across the Setpoint Demand terminals (55 and 56). Once voltage is applied, the Setpoint Demand segment turns on in the LCD.

## Boiler Target During Setpoint

The boiler target temperature during a Setpoint Demand is increased to at least the Setpoint setting. This temperature is maintained as long as the control has a setpoint demand.

## Setpoint During UnOccupied

The control has a Setpoint UnOccupied setting that allows the installer to select On or Off. When set to On, and the control receives a Setpoint Demand during an UnOccupied or Sleep period, the control continues operation of the Setpoint system as it would during Occupied and Wake periods. When set to Off, the control can ignore a Setpoint Demand for the duration of the UnOccupied and Sleep periods.

## Setpoint Modes

The Setpoint Mode determines the operation of the primary pump. The Setpoint Mode setting is found in the Adjust menu.

### Setpoint Mode 1 - Setpoint in Parallel

Whenever a setpoint demand is present, the boiler is operated to maintain the setpoint target. The primary pump (P1) does not turn on, but may operate based on either a Boiler, Mixing or a DHW Demand.

It is assumed that the Setpoint pump will provide adequate flow through the heat exchanger and the boiler.

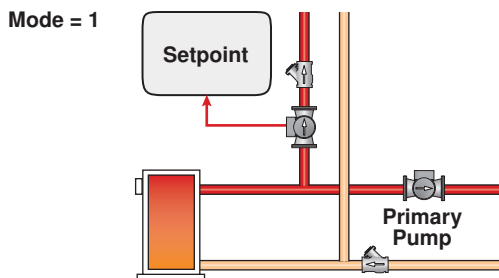

### Setpoint Mode 2 - Setpoint in Parallel with Priority

When a Setpoint Demand is present, the boiler is operated to maintain the setpoint target. The primary pump (P1) can operate when a boiler demand is present. If the boiler is unable to maintain the boiler target temperature, space heating zones are shut off sequentially using tN4 communication in order to provide priority for the setpoint load. This is known as zone load shedding.

It is assumed that the setpoint pump will provide adequate flow through the heat exchanger and the boiler.

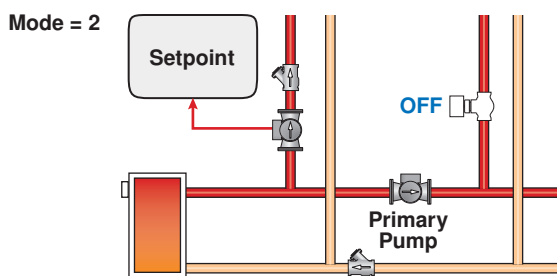

### Setpoint Mode 3 – Setpoint in Primary / Secondary

Whenever a setpoint demand is present, the primary pump (P1) is turned on and the boiler is operated to maintain the setpoint target.

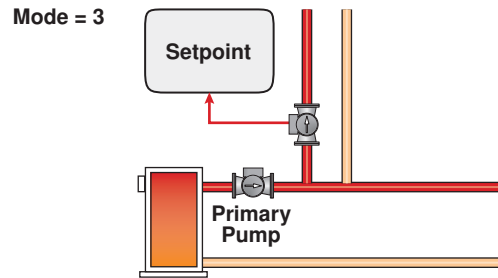

### Setpoint Mode 4 - Setpoint in Primary / Secondary with Priority

Whenever a Setpoint Demand is present, the primary pump (P1) is turned on and the boiler is operated to maintain the setpoint target. Space heating zones will be shut off using zone load shedding if the boiler is unable to maintain the boiler target temperature.

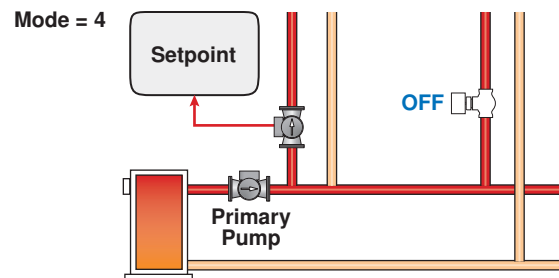

## Setpoint Priority Override

Setpoint Priority Override applies to SETPOINT MODE 2 and MODE 4. To prevent the building from cooling off too much or the possibility of a potential freeze up during setpoint priority, the control limits the amount of time for setpoint priority. As the outdoor air temperature becomes colder, the length of time the control provides setpoint priority is reduced. Once the allowed time for priority has elapsed, the control overrides the setpoint priority and resumes space heating.

## Conditional Setpoint Priority

If the boiler supply temperature is maintained at or above the required temperature during setpoint generation, this indicates that the boiler has enough capacity for setpoint and possibly heating as well. As long as the boiler target temperature is maintained, setpoint and heating occur at the same time.

**Primary Pump**

The primary pump is switched on in the following situations:

- There is a Boiler Demand and that zones thermostat has H1 Pump set to On.
- There is a Mix1 or Mix2 Demand.
- There is a DHW Demand and the control is set to DHW Mode 3 or 4.
- The control is completing a DHW Purge.
- There is a Setpoint Demand and the control is set to Setpoint Mode 3 or Mode 4.

**Mix System Pump P1**

The mixing pump P1 is switched on only when there is a Mix 1 Demand and that zone's thermostat has H1 Pump set to On.

**Variable Speed Pump**

The variable speed injection pump output operates only when there is a Mix 1 Demand and the Mixing item in the Adjust menu is set to variable speed injection pump (VAR).

**DHW Pump**

The DHW Pump operates whenever there is a DHW Demand and the control is not in DHW Priority Override.

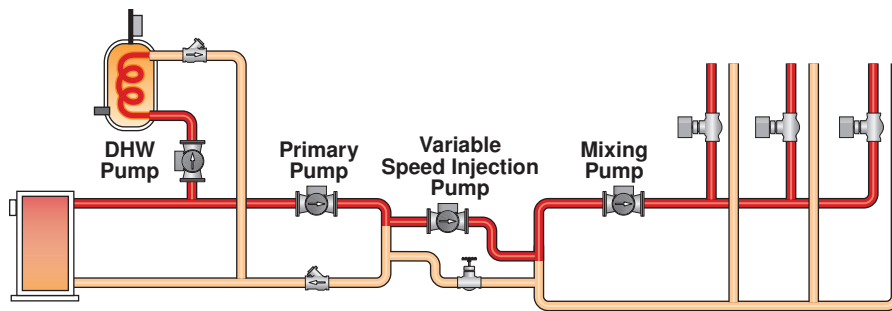

**Pump Exercising**

**Section L**

The system control will exercise all pumps, mixing valves and hydronic zones (zone valves and zone pumps) for 10 seconds every three days to prevent seizure.

# Error Messages

## Local Errors and Device Errors

Error messages are used to indicate a problem somewhere in the system. There are two types of error messages: Local Errors and Device Errors.

A Local Error indicates an error specific to a device. For example, a thermostat with a sensor short circuit will show a Sensor Short Error on its display. No other devices will show this specific error (unless they also have a sensor short circuit).

A Device Error is used to indicate that there is a local error somewhere else on the system. For example, if a thermostat has a sensor short circuit, that thermostat will show a Local Error indicating specifically what the problem is. All other devices on the network will show Device Errors, indicating the address of the device with the Local Error. In other words, Device Errors are nothing more than pointers, showing you that there is a local error somewhere on the system and where to find it.

## Error Priority

Only one error can be shown on a particular device at a time. If there is more than one error on the system, the highest priority error will be the one that is shown. The table on pages 22 and 23 lists error messages in order of high priority to low priority.

## How to Locate an Error Message

If the warning symbol (flashing circle with exclamation mark) is visible on screen, this indicates that there is an error somewhere on the system. To view the error message, you must first put the control into the Advanced or Installer access level (available in MISC menu). When an error message is present, it is available as an item in the VIEW menu.

While in the View Menu, press the item button until the error message is displayed. You may have to advance through several View Menu items before the message is displayed.

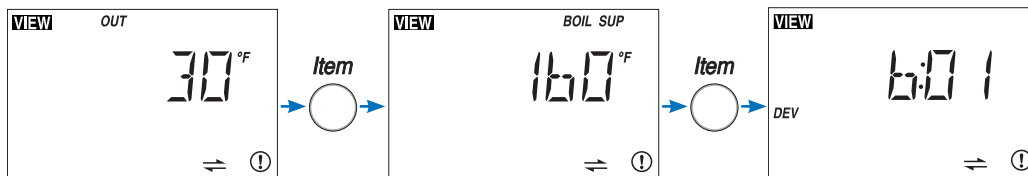

If the error message is a Device Error (if “DEV” or “DEV ERR” is shown on screen), read the address shown and go to the device with that address. That device will have a Local Error indicating specifically what the problem is. When the problem is corrected, the error message will automatically clear.

## Access Levels

In some cases, it is not desirable to let day-to-day users view error messages. In these cases, by lowering the access level of the thermostat or setpoint device to ‘User’ or lower, error messages cannot be seen in the View menu and the warning symbol only appears if there is a local error or a device error caused by a critical error on another device. If there is an error message on the system that you cannot find on a particular thermostat, make sure that the access level on that thermostat is set to Installer or Advanced.

## Sensor Temperature Errors



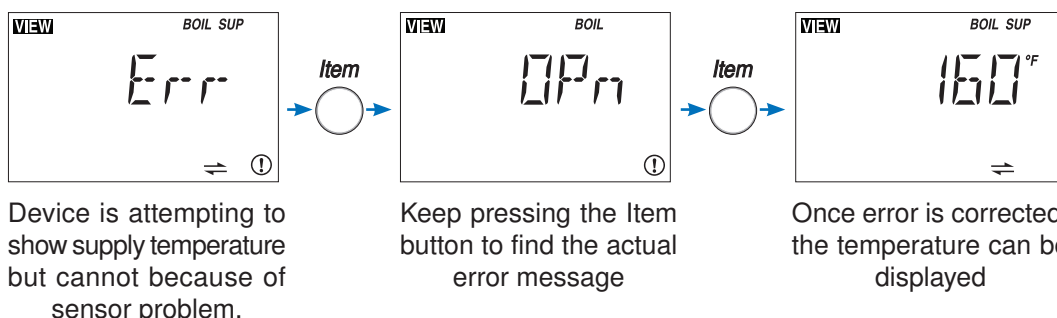

If a control is unable to display a temperature due to a sensor malfunction or communication problem, the word “Err” is displayed in place of the temperature. This usually indicates that there is an error somewhere on the system but is not the actual error message. Keep looking through the View menu to find the actual error message.

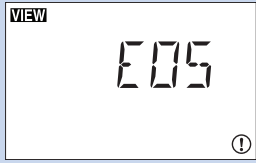
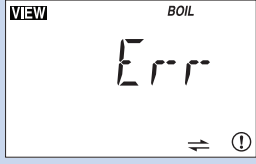
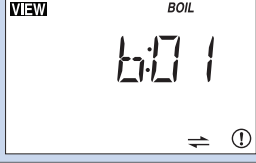
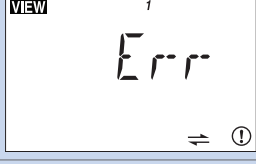
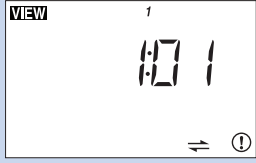
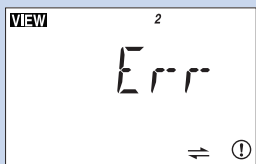
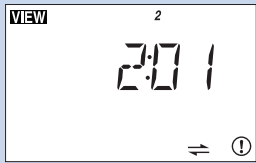
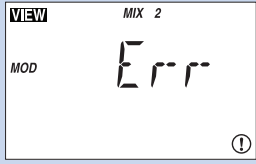
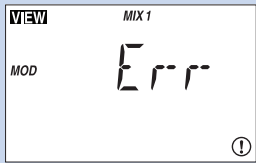

## Error Messages (1 of 3)

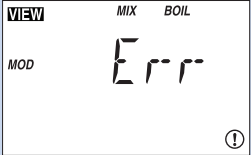
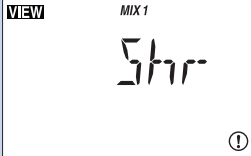
Error Message	Description
	<p><b>ADJUST ERROR</b></p> <p>The control failed to read the Adjust menu settings, and reloaded the factory default settings. Operation stops until you check the Adjust menu settings.</p> <p><b>Note:</b> To clear the error, the access level must be set to Advanced and the settings in the Adjust menu must be checked.</p>
	<p><b>MISCELLANEOUS ERROR</b></p> <p>The control failed to read the Miscellaneous menu settings, and reloaded the factory default settings. Operation stops until you check the Miscellaneous menu settings.</p> <p><b>Note:</b> To clear the error, the access level must be set to Advanced and the settings in the Misc menu must be checked.</p>
	<p><b>BOILER BUS ERROR</b></p> <p>Communication has been lost on the boiler bus. Check the tN4, C and R wires for each tN4 device. Check the polarity of the C and R wires. Check for loose or broken wires.</p>
	<p><b>BOILER BUS DEVICE LOST</b></p> <p>Communication is lost to a tN4 device at address AA on the Boiler bus. The LCD on the lost device displays Bus Boil OPn. Ensure that there is power to the lost device. Trace the wires from the control to the lost device looking for loose or damaged wires.</p> <p><b>Note:</b> If you deliberately remove a tN4 device, hold the Up and Down buttons to clear the error.</p>
	<p><b>BUS 1 ERROR</b></p> <p>Communication has been lost on the Mix 1 bus. Check the tN4, C and R wires for each tN4 device. Check the polarity of the C and R wires. Check for loose or broken wires.</p>
	<p><b>BUS 1 DEVICE LOST</b></p> <p>Communication is lost to tN4 device AA on the Mix 1 bus. The LCD on the lost device displays Bus 1 OPn. Ensure that there is power to the lost device. Trace the wires from the control to the lost device looking for loose or damaged wires.</p> <p><b>Note:</b> If you deliberately remove a tN4 device, hold the Up and Down buttons to clear the error.</p>
	<p><b>BUS 2 ERROR</b></p> <p>Communication has been lost on the Mix 2 bus. Check the tN4, C and R wires for each tN4 device. Check the polarity of the C and R wires. Check for loose or broken wires.</p>
	<p><b>BUS 2 DEVICE LOST</b></p> <p>Communication is lost to tN4 device AA on the Mix 2 bus. The LCD on the lost device displays Bus 2 OPn. Ensure that there is power to the lost device. Trace the wires from the control to the lost device looking for loose or damaged wires.</p> <p><b>Note:</b> If you deliberately remove a tN4 device, hold the Up and Down buttons to clear the error.</p>
	<p><b>BUS 2 MODULE ERROR</b></p> <p>The control lost communication with the Mixing Module or more than one Mixing Module has been connected to Bus 2. Ensure that there is only one Mixing Module on Bus 2 and that there is power to the Mixing Module. Trace the bus wires from the control to the Mixing Module looking for any loose or damaged wires.</p>
	<p><b>MIX 1 MODULE ERROR</b></p> <p>A Mixing Module has been connected to the Mix 1 bus. Ensure that there is not a Mixing Module on the Mix 1 bus.</p>

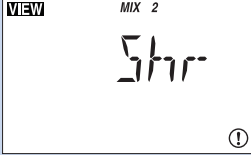
## Error Messages (2 of 3)

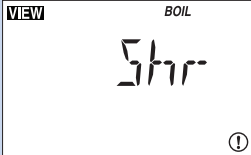
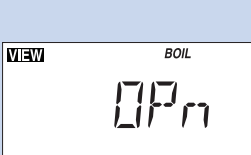
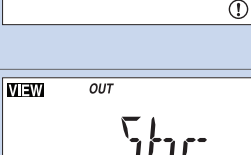
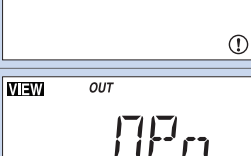
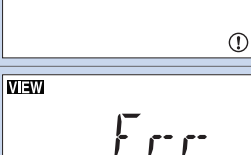
Error Message	Description
 <p>VIEW MIX BOIL MOD Err</p>	<p><b>MIXING EXPANSION MODULE CONFLICT</b></p> <p>A Mixing Expansion Module is connected to the Boiler bus. The Mixing Expansion Module must be removed from the Boiler bus or the bus must be set to Mix 2 via the tN4 Boiler / Mix2 DIP switch. The error message self clears once the error condition is corrected.</p>
 <p>VIEW MIX 1 Shr</p>	<p><b>MIX 1 SENSOR SHORT CIRCUIT</b></p> <p>Due to a short circuit, the control failed to read the Mix 1 supply sensor. As a result, the control operates mixing device 1 at a fixed output as long as there is a call for heat. Locate and repair the problem as described in the Data Brochure D 070.</p>
 <p>VIEW MIX 1 OPn</p>	<p><b>MIX 1 SENSOR OPEN CIRCUIT</b></p> <p>Due to an open circuit, the control failed to read the Mix 1 supply sensor. The control operates the mixing device 1 at a fixed output as long as there is a call for heat. Locate and repair the problem as described in the Data Brochure D 070.</p>
 <p>VIEW MIX 2 Shr</p>	<p><b>MIX 2 SENSOR SHORT CIRCUIT</b></p> <p>Due to a short circuit, the control failed to read the Mix 2 supply sensor. The Mix 2 supply sensor is connected to the Mixing Module. The control operates the mixing device 2 at a fixed output as long as there is a call for heat. Locate and repair the problem as described in the Data Brochure D 070..</p>
 <p>VIEW MIX 2 OPn</p>	<p><b>MIX 2 SENSOR OPEN CIRCUIT</b></p> <p>Due to an open circuit, the control failed to read the Mix 2 supply sensor. The Mix 2 supply sensor is connected to the Mixing Module. The control operates the mixing device 2 at a fixed output as long as there is a call for heat. Locate and repair the problem as described in the Data Brochure D 070.</p>
 <p>VIEW BOIL Shr</p>	<p><b>BOILER SENSOR SHORT CIRCUIT</b></p> <p>Due to a short circuit, the control failed to read the boiler sensor. When there is a call for heat, the control no longer controls the boiler(s). Instead, the control provides a boiler enable to the boiler's aquastat or boiler control until the sensor is repaired. The control will not operate the boiler contact if the Boil Minimum setting is less than 100°F (38.0°C). Locate and repair the problem as described in the Data Brochure D 070.</p>
 <p>VIEW BOIL OPn</p>	<p><b>BOILER SENSOR OPEN CIRCUIT</b></p> <p>Due to an open circuit, the control failed to read the boiler sensor. The control no longer controls the boiler. Instead, the control provides a boiler enable to the boiler's aquastat or boiler control until the sensor is repaired. The control will not operate the boiler contact if the Boil Minimum setting is less than 100°F (38.0°C). Locate and repair the problem as described in the Data Brochure D 070.</p> <p><b>Note:</b> If you deliberately remove the boiler sensor, set the Boiler Sensor Return / Supply DIP switch to Return. Power down for 10 seconds then restart the control.</p>
 <p>VIEW OUT Shr</p>	<p><b>OUTDOOR SENSOR SHORT CIRCUIT</b></p> <p>Due to a short circuit, the control failed to read the outdoor sensor. As a result, the control assumes an outdoor temperature of 32°F (0.0°C) and continues operation. Locate and repair the problem as described in the Data Brochure D 070.</p>
 <p>VIEW OUT OPn</p>	<p><b>OUTDOOR SENSOR OPEN CIRCUIT</b></p> <p>Due to an open circuit, the control failed to read the outdoor sensor. As a result, the control assumes an outdoor temperature of 32°F (0.0°C) and continues operation. Locate and repair the problem as described in the Data Brochure D 070.</p>
 <p>VIEW DEV SCHED Err</p>	<p><b>DEV SCHED</b></p> <p>The selected system schedule is no longer available. Either the system schedule master is no longer connected to the network or the system schedule number has been changed on the schedule master.</p>

## Error Messages (3 of 3)

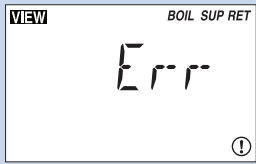
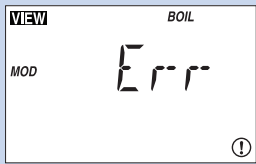
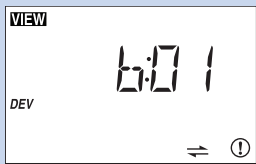
Error Message	Description
	<p><b>BOILER BUS AND RETURN SENSOR CONFLICT</b></p> <p>There is a DIP switch settings conflict. The Boiler DIP switch is set to Ret and the tN4 bus DIP switch is set to Boiler. Once the Boiler DIP switch is set to Sup or the tN4 bus DIP switch is set to Mix 2, the error message clears.</p>
	<p><b>tekmar STAGER SETTING CONFLICT</b></p> <p>There is a DIP switch settings conflict. The tekmar Stager DIP switch is set to On and the Boiler Sensor DIP switch is set to Ret. Once the Boiler Sensor DIP switch is set to Sup or the tekmar Stager DIP switch is set to Off, the error message clears.</p>
	<p><b>DEVICE ERROR AT ADDRESS #:#</b></p> <p>#:# is the address of the device with the error. The bus number displays before the colon, and the device number displays after. Go to the device with the address displayed.</p> <p><u>Possible Addresses:</u></p> <p><b>b:01 to b:24</b> - Device Error on Boiler Bus  <b>1:01 to 1:24</b> - Device Error on Bus 1  <b>2:01 to 2:24</b> - Device Error on Bus 2</p>

## Troubleshooting

Symptom	Possible Causes	Corrective Action
Boiler does not fire when there is a DHW or Setpoint Demand	No voltage present on demand terminals.	Test voltage across demand terminals using voltmeter.
	Control in Unoccupied and DHW Unoccupied or Setpoint Unoccupied set to OFF.	Check which schedule the 422 is operating on.
	Boiler contact is not connected to boiler thermostat connection.	Trace wires from boiler contact to boiler thermostat connection. Use the Test sequence to check the boiler contact.
Mixing valve will not open.	No voltage present on actuator motor.	Mix 1 Mode setting must be set to FLt.
	Boiler Return Protection.	Mixing valve will not open until the boiler supply temperature exceeds the boiler minimum setting.
	Actuator rotating in wrong direction to open valve	Reverse open and close wires on actuator.
Variable speed injection pump does not operate.	No current present on variable speed injection pump.	Mix 1 Mode setting must be set to VAR.
	Boiler Return Protection.	Variable speed injection pump will not operate until the boiler supply temperature exceeds the boiler minimum setting.
	A non-wet rotor pump has been installed.	Variable speed injection will only operate with wet rotor pumps. Read E 021 and check pump type.
	Fuse is blown.	Determine if pump is jammed or seized. Replace fuse.
Display is not on.	No voltage to control.	Check breaker panel or disconnect. Check voltage using a voltmeter.
	Plugs are not connected between the 422 to the Zone Manager.	Ensure the plugs are secured to the Zone Manager pins.
	Fuse is blown.	Check fuse on Zone Manager. Check total VA draw on all thermostats and zone valves connected to the Zone Manager. This cannot exceed 40 VA.

## Limited Warranty and Product Return Procedure

**Limited Warranty** *The liability of tekmar under this warranty is limited. The Purchaser, by taking receipt of any tekmar product ("Product"), acknowledges the terms of the Limited Warranty in effect at the time of such Product sale and acknowledges that it has read and understands same.*

The tekmar Limited Warranty to the Purchaser on the Products sold hereunder is a manufacturer's pass-through warranty which the Purchaser is authorized to pass through to its customers. Under the Limited Warranty, each tekmar Product is warranted against defects in workmanship and materials if the Product is installed and used in compliance with tekmar's instructions, ordinary wear and tear excepted. The pass-through warranty period is for a period of twenty-four (24) months from the production date if the Product is not installed during that period, or twelve (12) months from the documented date of installation if installed within twenty-four (24) months from the production date.

The liability of tekmar under the Limited Warranty shall be limited to, at tekmar's sole discretion: the cost of parts and labor provided by tekmar to repair defects in materials and / or workmanship of the defective product; or to the exchange of the defective product for a warranty replacement product; or to the granting of credit limited to the original cost of the defective product, and such repair, exchange or credit shall be the sole remedy available from tekmar, and, without limiting the foregoing in any way, tekmar is not responsible, in contract, tort or strict product liability, for any other losses, costs, expenses, inconveniences, or damages, whether direct, indirect, special, secondary, incidental or consequential, arising from ownership or use of the product, or from defects in workmanship or materials, including any liability for fundamental breach of contract.

The pass-through Limited Warranty applies only to those defective Products returned to tekmar during the warranty period. This Limited Warranty does not cover the cost of the parts or labor to remove or transport the defective Product, or to reinstall the repaired or replacement Product, all such costs and expenses being subject to Purchaser's agreement and warranty with its customers.

Any representations or warranties about the Products made by Purchaser to its customers which are different from or in excess of the tekmar Limited Warranty are the Purchaser's sole responsibility and obligation. Purchaser shall indemnify and hold tekmar harmless from and against any and all claims, liabilities and damages of any kind or nature which arise out of or are related to any such representations or warranties by Purchaser to its customers.

The pass-through Limited Warranty does not apply if the returned Product has been damaged by negligence by persons other than tekmar, accident, fire, Act of God, abuse or misuse; or has been damaged by modifications, alterations or attachments made subsequent to purchase which have not been authorized by tekmar; or if the Product was not installed in compliance with tekmar's instructions and / or the local codes and ordinances; or if due to defective installation of the Product; or if the Product was not used in compliance with tekmar's instructions.

THIS WARRANTY IS IN LIEU OF ALL OTHER WARRANTIES, EXPRESS OR IMPLIED, WHICH THE GOVERNING LAW ALLOWS PARTIES TO CONTRACTUALLY EXCLUDE, INCLUDING, WITHOUT LIMITATION, IMPLIED WARRANTIES OF MERCHANTABILITY AND FITNESS FOR A PARTICULAR PURPOSE, DURABILITY OR DESCRIPTION OF THE PRODUCT, ITS NON-INFRINGEMENT OF ANY RELEVANT PATENTS OR TRADEMARKS, AND ITS COMPLIANCE WITH OR NON-VIOLATION OF ANY APPLICABLE ENVIRONMENTAL, HEALTH OR SAFETY LEGISLATION; THE TERM OF ANY OTHER WARRANTY NOT HEREBY CONTRACTUALLY EXCLUDED IS LIMITED SUCH THAT IT SHALL NOT EXTEND BEYOND TWENTY-FOUR (24) MONTHS FROM THE PRODUCTION DATE, TO THE EXTENT THAT SUCH LIMITATION IS ALLOWED BY THE GOVERNING LAW.

**Product Warranty Return Procedure** All Products that are believed to have defects in workmanship or materials must be returned, together with a written description of the defect, to the tekmar Representative assigned to the territory in which such Product is located. If tekmar receives an inquiry from someone other than a tekmar Representative, including an inquiry from Purchaser (if not a tekmar Representative) or Purchaser's customers, regarding a potential warranty claim, tekmar's sole obligation shall be to provide the address and other contact information regarding the appropriate Representative.



tekmar Control Systems Ltd., Canada  
tekmar Control Systems, Inc., U.S.A.  
**Head Office: 5100 Silver Star Road**  
**Vernon, B.C. Canada V1B 3K4**  
**(250) 545-7749 Fax. (250) 545-0650**  
**Web Site: [www.tekmarcontrols.com](http://www.tekmarcontrols.com)**

