

Installation, Operation and Maintenance Manual

CLX Online Residual Chlorine Analyzer



Table of Contents

1.0 Understanding Safety Information.....	3	8.0 Additional Features and Options.....	19
1.1 Symbols Used in this manual.....	3	8.1 Modbus Communication	19
2.0 Introduction to the Unit.....	3	8.2 Desiccant Cartridge Option(Catalog #09944).....	19
2.1 Overview	3	9.0 Troubleshooting.....	19
2.4 Display	4	9.1 CLX Fault Detection.....	19
2.5 The Keypad.....	5	9.2 Diagnostic testing.....	20
3.0 Theory of Operation.....	5	9.2.1 Noise Measure	20
4.0 Installation and Commissioning.....	6	9.2.2 Flow Measure.....	20
4.1 Mounting and Site Selection	6	9.2.3 LED testing.....	20
4.2 Plumbing	6	9.2.4 Solenoid testing.....	21
4.3 Electrical Connections	7	9.2.5 Analog testing	21
4.3.1 Power.....	8	9.2.6 Alarms testing.....	21
4.3.2 RS-485.....	8	9.2.7 Environment	21
4.3.3 Alarm Relays	8	9.3 Setting Flow Rate	21
4.3.4 4-20 mA.....	8	9.4 Clearing Faults.....	21
4.3.5 Remote Standby	8	9.5 Reagent Clogs.....	21
4.4 Installing Reagents.....	8	9.6 Diagnostic Chart.....	22
5.0 Operation	9	9.7 Technical and Customer Assistance.....	22
5.1 Routine Measurement.....	9	10.0 Routine Maintenance / Servicing.....	23
5.2 Security Access Feature	9	10.1 Normal Maintenance Schedule	23
5.3 The White LED.....	9	10.2 Preventative Maintenance Schedule	24
6.0 Instrument Calibration.....	10	10.3 Replacing or Installing the Chassis Assembly.....	25
6.1 Slope Calibration Procedure	10	10.4 Replacing or Installing the Reagents	26
6.2 Zero Calibration Procedure	10	10.5 Check Valve Flushing Kit.....	27
6.3 Restore Factory Settings.....	11	10.6 Instrument Storage.....	27
7.0 Instrument Configuration (CONFIG mode).....	11	10.7 Cleaning the CLX.....	27
7.1 Setting the 4-20 mA Output.....	11	11.0 Accessories and Replacement Parts List	28
7.2 4mA Calibration Trim Adjustment.....	12	12.0 Warranty.....	32
7.3 20mA Calibration Trim Adjustment.....	12		
7.4 Configuring the Error Level.....	13		
7.5 Configuring the Modbus RS-485.....	13		
7.6 Configuring the Modbus TCP	14		
7.7 Configuring the Alarms	15		
7.7.1 Alarm 1.....	15		
7.7.2 Alarm 2.....	15		
7.8 Remote Standby.....	15		
7.9 Units of Measurement.....	16		
7.10 Averaging	16		
7.11 Resolution	16		
7.12 LCD Backlight Brightness.....	16		
7.13 About Device.....	17		
7.14 Water Conservation	17		
7.15 Code / Enabling the Security Access.....	17		
7.16 USB Options	18		
7.17 Date / Time.....	18		
7.18 Instrument ID.....	18		
7.19 Extended Range.....	19		

⚠ WARNING



Read this Manual BEFORE using this equipment.
Failure to read and follow all safety and use information can result in death, serious personal injury, property damage, or damage to the equipment.
Keep this Manual for future reference.

1.0 Understanding Safety Information

This manual contains basic instructions that must be followed during the commissioning, operation, care, and maintenance of the instrument. The safety protection provided by this equipment may be impaired if it is commissioned and/or used in a manner not described in this manual. Consequently, all responsible personnel must read this manual prior to working with this instrument and follow the safety precautions in this manual.

In certain instances, icons or symbols, have been added to give further clarification to the instructions. Refer to the *Table of Contents* to easily find specific topics and to learn about unfamiliar terms.

1.1 Symbols Used in this manual



This symbol identifies hazards which, if not avoided, could result in minor or moderate injury or damage to the equipment.



This symbol identifies important information, practices or actions.



This pictorial alert you to the need read the manual, possibly at a different section.



This pictorial alerts you to electricity, electrocution, and shock hazards.

2.0 Introduction to the Unit

2.1 Overview

The CLX Online Chlorine Analyzer allows for continuous reading of chlorine levels in process water. The CLX has been designed to meet the criteria specified by Standard Methods for the Examination of Water and Wastewater (24th Edition) Method 4500-Cl G. DPD Colorimetric Method and to meet EPA Method 334.0: Determination of Residual Chlorine in Drinking Water Using An On-line Chlorine Analyzer

Due to the continuous development and improvement of all instrumentation, there may be slight differences between this manual and the instrument received. The latest version of the manual can be downloaded from www.hfscientific.com.

2.2 Specifications

Call customer service if you need assistance with technical details.

Measurement Range	0.01 – 10.00 mg/L (PPM) 0.01 – 15.00 mg/L (PPM) (Extended range = ON)
Accuracy	±5% of reading or ±0.03 mg/L (PPM) whichever is greater for range of 0-6.0 mg/L(PPM) ±10% of reading from 6.01-15.00 mg/L (PPM)
Resolution	0.001 mg/L (PPM)
Cycle Time	Adjustable; 60 seconds to 10 minutes (600 seconds) Note: The system defaults to 2.5 minutes (150 seconds)
Display	3.5" Liquid Crystal Display TFT Module
Alarm	Two Programmable, 120 - 240VAC 2A Form C Relay
Remote Standby	One Programmable, 12 - 24V operation
USB	Type C for error / data log download or firmware update
Analog Output	Powered 4-20 mA, 1000 Ω drive, isolated
Communications Port	Bi-directional RS-485 with Modbus or Modbus TCP
Water Pressure	Internal pressure regulator 0.34 bar (5.0 PSI) to 10.3 bar (150 PSI.)
Flow Rate to Waste	200 – 400 ml/min.
Operating Temperature	0°C – 40°C (32°F – 104°F)
Wetted Materials	PVC, Borosilicate Glass, Reslyn (FFKM), Viton® (FKM), Polypropylene, Stainless Steel, Acetal, Noryl®, Silicone
Sample Temperature Range	0°C – 40°C (32°F – 104°F) Operating temperature for 30-day reagent life is 0-40°C (32°F – 104°F) Reagent life will be <30 days if kept at temperatures above 40°C
Power Supply	100 – 240 VAC, 50 / 60 Hz, 80VA
Insulation Rating	Double Insulated, Pollution Degree 2, Overvoltage Category II
Environmental Conditions	Not Intended or Designed for Outdoor Use. Up to 95 % RH (non-condensing) Altitude up to 2000m
Regulatory Compliance and Certifications	CE Approved, Listed to UL 61010-1: 2012 Ed 3 Certified to CAN/CSA-C22.2 #61010-1-12: 2022 EMC to EN61326-1: 2021
Shipping Weight	3.9 kg (8.6 lbs.) Reagents Shipped Separately
Shipping Dimensions	406 mm X 406 mm X 241 mm (16" X 16" X 9½")
Warranty	2 Years from date of sale

*Viton® is a trademark of The Chemours Company FC, LLC
Noryl® is a registered trademark of SABIC Global Technologies B.V.

2.3 Unpacking and Inspection of the Instrument and Accessories

The table below indicates the items in the shipment.

Item	Quantity
CLX Analyzer	1
Instruction Manual	1
Mounting Kit	1
Tubing/Cuvette Kit: 8 black pump tubes, 2 Cap Assemblies, 1 cuvette	1
In-Line Strainer Kit	1
Check Valve Flushing Kit	1

Remove the instrument from the packing carton. Carefully inspect all items to ensure that no visible damage has occurred during shipment. If the items received do not match the order, please immediately contact the local distributor or the HF scientific Customer Service Department.

2.4 Display

The display is a 3.5" Liquid Crystal Display TFT Module. It contains a configurable setting to adjust the brightness of the backlight. Depending on the screen selection of the setting, the display will load different screens for the user. There are 3 main screens.

- Home – Figure 1
- Service – Figure 2
- Configuration – Figure 3

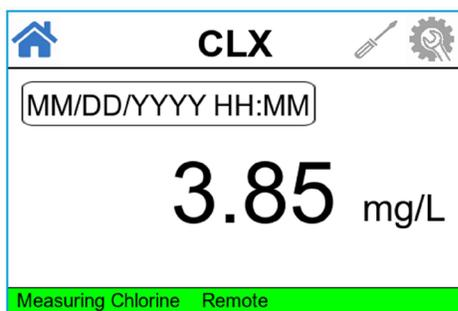

Figure 1: Home screen

The Home screen displays the current reading, date, time, countdown remaining in a cycle and any errors or warnings that the system is experiencing. If the demo mode is enabled, the word "Demo Mode" is displayed on the lower left of the Home screen.

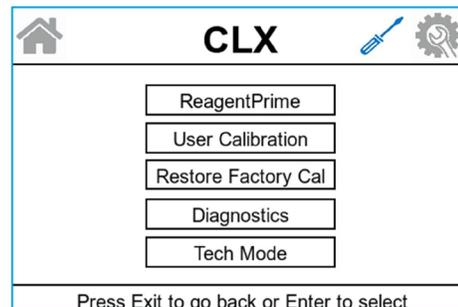
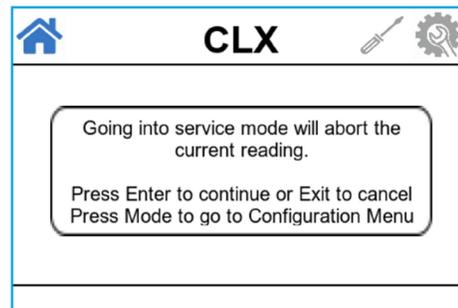

Figure 2: Service screen

Prior to entering service mode, a warning pop up box will appear. If the user goes into the service mode, the current reading will be aborted. Service mode will drain the cuvette and halt the operation of the instrument so that user can perform maintenance or cleaning of the instrument.

The Service screen displays reagent priming, user calibration, restore factory calibration settings and the diagnostics option to allow user to run diagnostic test on selected functions to aid in troubleshooting of the instrument, system warnings or errors or during cleaning or flushing of the instrument.

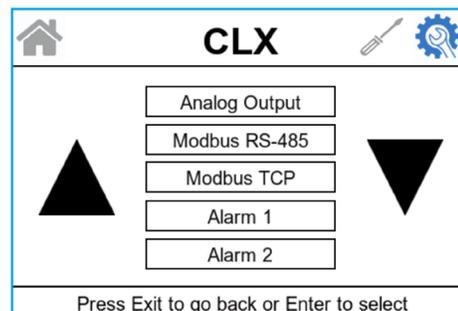

Figure 3: Config screen

The Configuration screen displays and allows the user to change or program the different settings of the instrument

2.5 The Keypad

Figure 4 illustrates the keypad. The keypad has seven buttons:

- Exit,
- Mode
- ↵
- ▲
- ▼
- ►
- ◀

The **MODE** button is used to cycle between the three operational modes of the instrument: Home (Measurement), Service (Priming and Diagnostics) and Config mode. The "Enter" ↵ button selects the option or mode that is highlighted. The ◀, ►, ▲ and ▼ buttons are used to change settings or to toggle between the selection.

To prime the reagent, the user must enter Service mode. The priming will start at 75 reagent pump pulses to prime the tubing after a change or addition of reagent bottles. While in Service mode, it will drain the instrument and hold all operations until either the **Exit** button is pushed or the power is reset. This button should be used while changing the tubing, the measurement cuvette or reagent bottles. Upon exiting Service mode, the instrument will attempt to run a cycle (unless remote option is enabled).

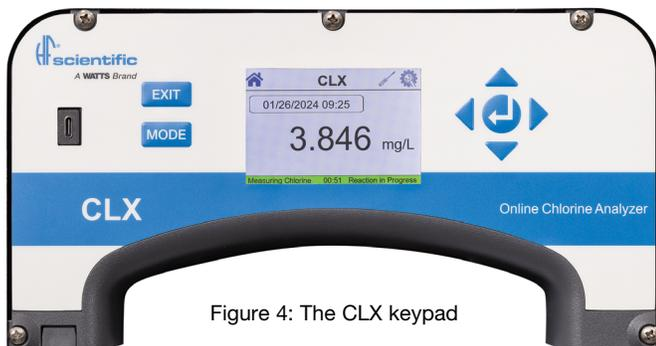

Figure 4: The CLX keypad

3.0 Theory of Operation

The CLX has two solenoid valves, one for sample water intake (FLOW) and one for draining of the cuvette (PURGE). A third solenoid, along with four check valves, forms a reagent pump. Sample water flow is controlled by the FLOW solenoid valve. The PURGE solenoid valve is used to empty the cuvette in the measurement chamber.

The measurement chamber consists of a sample inlet, a purge drain, and an overflow. The reagent is added from the check valves integrated into the lower portion. A green LED provides the 515 nm source lamp, a red LED is used for sample level and flow measurement. A single detector is located 180° from the green LED. A replaceable glass cuvette separates the LEDs from the detector and maintains the measurement path length. Sample water flows in the inlet at the bottom, through the measurement cuvette and out through an overflow drain. This flow is used to both fill the cuvette and flush the system.

The reagents are dispensed from two replaceable bottles. One bottle has a buffer to control the pH; the second has an indicator that contains the DPD, which produces color when chlorine is present in the sample. The degree of color is dependent on the amount of chlorine in the sample water.

The measurement chamber is open to view operations. A white LED backlights the chamber for a clearer view. The white LED will flash to attract attention in the case of a warning or failure. Most warnings and failures are also displayed on the screen. To prevent interference, the white LED is turned off during measurements.

During normal operation the CLX will run through a timed cycle. A simplified cycle will consist of the following process step sequences:

- Cleaning – Continuous sample flow (cleaning)
- Pre-Wash – Washing of the cuvette by pulsing the intake and purge
- Filling solution – Filling the cuvette with sample water
- Zero Sample – Initial measurement of the sample intake
- Reaction in Progress – Reaction time of reagents mixing with the sample
- Sampling – Measurement of the sample intake after its reaction with reagents
- Post-Wash – With water conservation feature set to OFF

The cycle above is simplified and does not describe all the actions and testing that occurs. The CPU continuously diagnoses the entire system for correct operation and sample water flow. If an error occurs, a message is posted to the message queue on the LCD screen.

The reagent is added by a single pulse of the reagent solenoid. When the reagents require replacement, the reagent priming function (in Service mode) is used to bring new reagents into the system. This is done usually after replacement of reagent bottles during servicing. During priming, the reagent solenoid is pulsed several times to draw fluid from the two reagent bottles and fill the tubes with new reagent. A complete reagent priming takes less than a minute.

Service mode empties the cuvette, stops the flow of sample water, and clears any errors. This provides a convenient way to replace reagents and the measurement cuvette. If more extensive servicing is performed, all power to the CLX should be removed. If the CLX is to be turned off, it is recommended that the user enters Service mode and perform a manual water intake and drain flush before removing power. This ensures that the cuvette is emptied, and the flow is off.

4.0 Installation and Commissioning

The instrument was calibrated and tested prior to leaving the factory and is suitable for accurate use directly out of the box.

A 2.0 mg/l (2PPM) check standard is available which allows the user to periodically check the instrument calibration.



Prior to use for the first time, one of the reagents (the indicator) will have to be mixed. Refer to Section 10.2 *Replacing or Installing the Reagents*.

4.1 Mounting and Site Selection

The instrument is designed for wall mounting. If wall mounting is not practical, the instrument can be mounted on any suitable level surface. Choose a location that is easily accessible for operation and service and ensure that the front display rests at eye level. Consideration must be made the plumbing connections. The overall mounting dimensions of the instrument are shown in Figure 5.

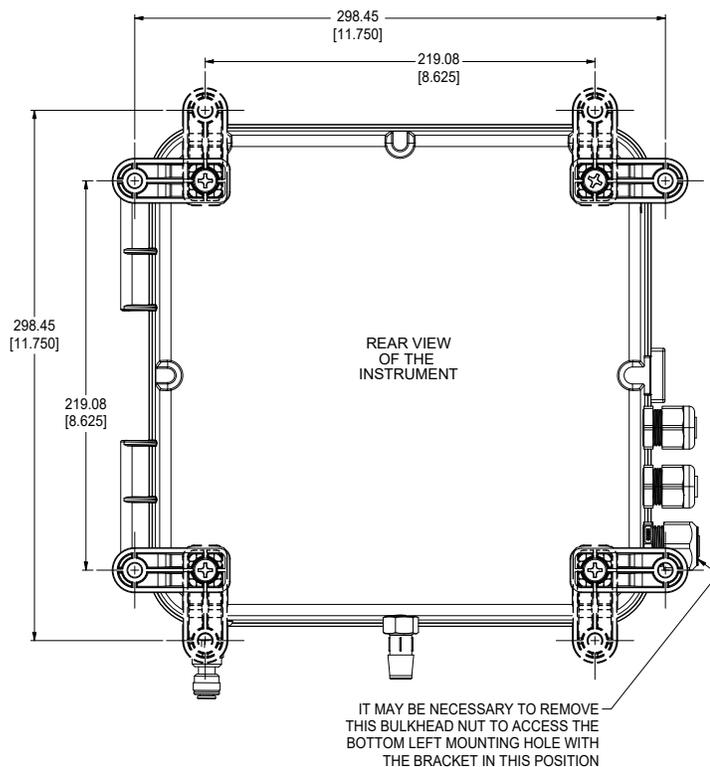

Figure 5: Overall Mounting Dimensions of the Instrument

It is critical that the instrument be mounted as close as possible to the sampling point to ensure a quick response time (within 2-3 meters (6-10 ft) of the sampling point). This analyzer has a fast loop to keep continuous sample flow.

The provided mounting feet will need to be installed with the provided screws. These can be rotated as shown above. Suggested mounting screws are up to M6 (1/4").

4.2 Plumbing

The recommended plumbing for the instrument is shown in Figure 6. The instrument is designed to require very little head pressure to operate but will need around 0.34 bar (5 PSI). The maximum pressure for proper operation should not exceed 10.3 bar (150 PSI). The maximum allowable fluid temperature is 40°C (104°F).

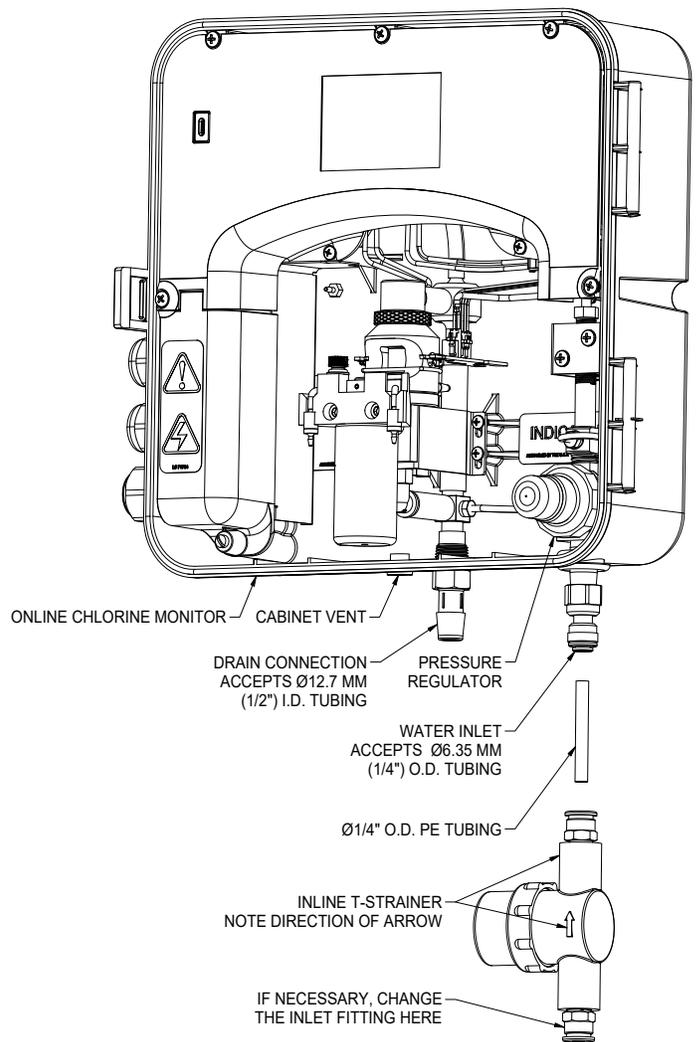

Figure 6: Recommended Plumbing for the Instrument

The supplied T-strainer must always be used to prevent clogging of the instrument. 1/4" quick connect fittings are supplied on the T strainer. If a pipe fitting change is required, this adaptation should be made at the T-strainer, not the instrument. Opaque tubing is recommended be used if the tubing will be exposed to sunlight, to prevent algae growth. Please note that the supplied connectors are compatible with 1/4" O.D. semi-rigid or rigid tubing.

The instrument is equipped with an internal cabinet drain (vent) to prevent damage in the event of a tubing failure. The drain tubing connects to a hose barb. The rated tubing size is 1/2" ID tubing. It is recommended that opaque tubing be used to prevent algae growth. Keep this tubing as short as possible. This drain must be kept open to the atmosphere.

NOTICE

To prevent water flow backup in the instrument, the drain MUST be open to atmosphere and must flow freely to drain and contain no loops in the tubing.

NOTICE

The fluid waste from drain connection of this instrument contains reagents diluted with large quantities of sample water. Check with local authorities concerning proper disposal of waste fluids. This waste fluid must NEVER be reintroduced into the incoming water stream.

4.3 Electrical Connections



Only qualified electricians should be allowed to perform the installation of the instrument as it involves a line voltage that could endanger life.

All of the electrical connections to the instrument are made at the termination area which is located on the left side of the instrument. Remove the high voltage cover by loosening the captive screw. Refer to Figure 7. The connections are labeled and are self-descriptive (see Figure 7). **Please follow all local and government recommendations for installation of electrical connections to and between the instrument and other peripheral devices.**

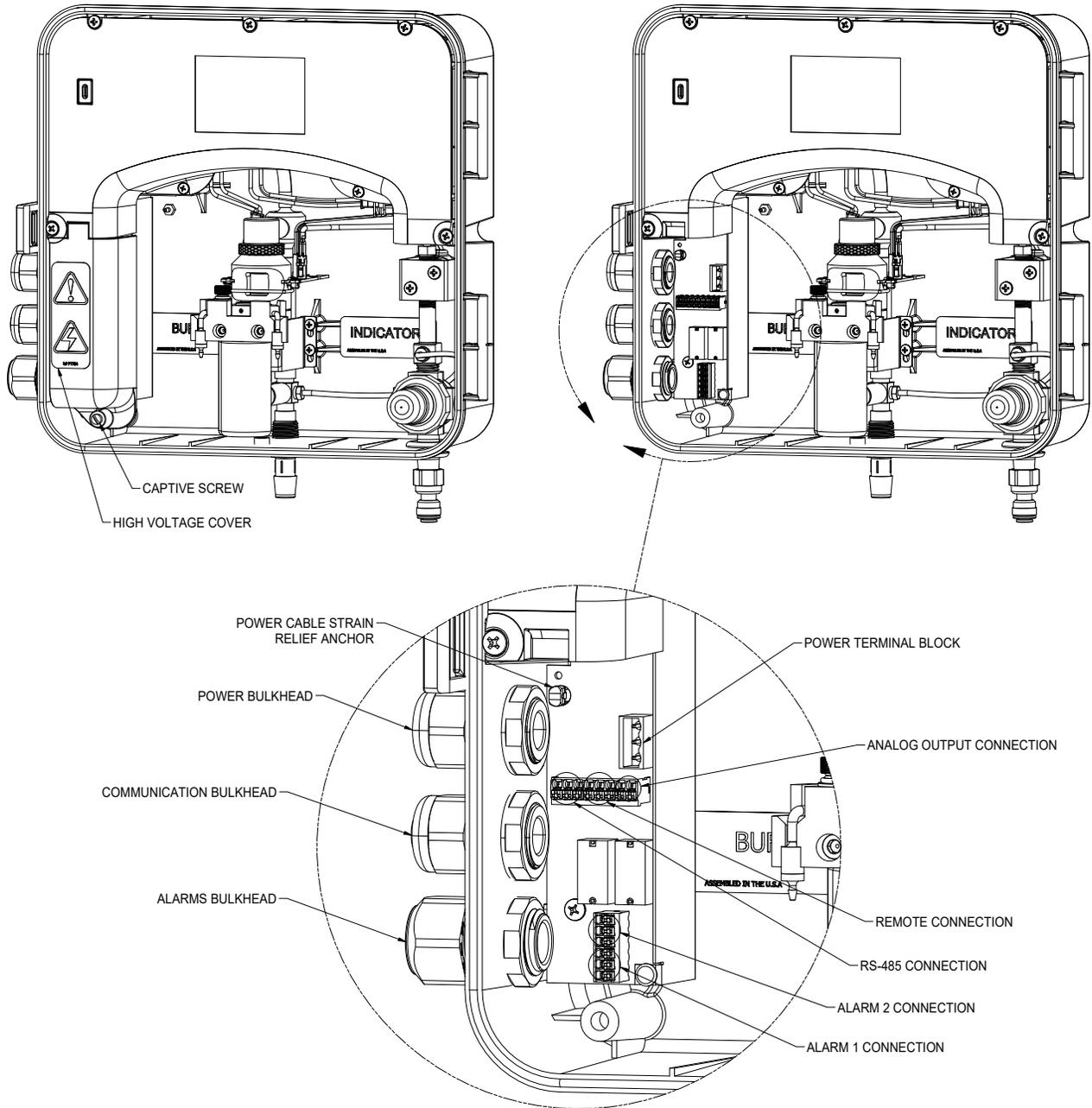

Figure 7: Connections for Instrument

Plugs are inserted into the RS-485 and 4-20mA cable bulkheads when shipped, to ensure a watertight seal. These plugs should be removed and discarded when cabling to either of these connections.

The power cable bulkhead will accept cable diameters from 5.8mm (.230 in.) up to 10 mm (.395 in.). All terminals are designed to accept wires in the range of 14-28 AWG. All wires should be stripped to a length of 6 mm (¼").

A strain relief strap is provided to reduce tension on the power terminals. It is the user's responsibility to assure that a watertight seal is maintained after the CLX has been wired for operation. If any of the bulkheads are not tightened properly around a cable or plug, the ratings of the instrument will be jeopardized and there is a possibility of creating a shock hazard.

4.3.1 Power

The instrument is equipped with 100-240 VAC, 50 / 60 Hz power supply requiring 80VA; please verify that the line voltage falls within these specifications. It is recommended that a circuit breaker of 5A be placed prior to the power connection to allow for service. It is recommended that the connection be less than 2 meters (six feet) from the instrument. While making connections, refer to Figure 7.

The CLX is intended for cord connection with a three wire non-locking grounded power cord, however rigid or flexible conduit connections can be used. A power cord can be purchased separately from the factory (Catalog No. 20779S). **The CLX is not supplied with a power cord.** If the CLX is to be used in the U.S. or Canada the power cord must be UL Listed and CSA Certified. Please consult all local electrical codes for proper connection. The connection block is marked N for Neutral and L for line the third symbol indicates a secure earth ground. The removable terminal block plug is suitable for wire gauges 18 to 12 AWG.

4.3.2 RS-485

The RS-485 half-duplex (2-wire) digital interface operates with differential levels that are not susceptible to electrical interferences. This is why cable lengths up to 3000 ft can be implemented. The last device on each bus may require terminating with a 120-ohm resistor to eliminate signal reflection on the line. Do not run RS-485 cables in the same conduit as power. Set-up of the RS-485 is covered in 7.3 *Configuring the RS-485 Port*.



To prevent damage to the instrument, ensure that power is disconnected prior to making connections. For ease of connecting, remove the plug-in terminal block. Connections are labeled beside this termination on the PC board.

The recommended cable is 22 AWG shielded twisted pair. It is also recommended to crimp the wire with a ferrule (example: 9019000000) before inserting into the push to connect connector. To make a termination, simply crimp and push into the terminal.

4.3.3 Alarm Relays

The Alarm 1 and Alarm 2 relays are mechanical relays rated at 240 VAC 2A. Please note that the relays are labeled NO (Normally Open), NC (Normally Closed) and C (Common). As these alarms are configured fail-safe, the normal condition is with power applied to the CLX and in a non-alarm condition. Operation of these alarms is covered in Section 7.6 *Configuring the Alarms*.



The recommended cable is 22 AWG shielded twisted pair. It is also recommended to crimp the wire with a ferrule (example: 9019000000) before inserting into the push to connect connector. To make a termination, simply crimp and push into the terminal.

The push to connect connector are rated for wire gauges 28-14.

4.3.4 4-20 mA



The 4-20 mA output is driven by a 28 VDC power source and can drive recorder loads up to 1000 ohms. Transformer isolation is provided on the CLX. Do not run 4-20 mA cables in the same conduit as power. Operation of this output is covered in Section 7.



To prevent damage to the instrument, and for general safety and to protect against the risk of electric shock, make sure that the power is disconnected to the CLX prior to making any connections. Polarities of the connections are labeled beside this termination on the PC board.

The recommended cable is 22 AWG shielded twisted pair. To prevent ground loops, connect the shield at **either** the CLX or at its destination, but not both. It is also recommended to crimp the wire with a ferrule (example: 9019000000) before inserting into the push to connect connector. To make a termination, simply crimp and push into the terminal.

The 4-20mA is factory calibrated. An adjustment is available on the 4-20mA in Section 7.3. In addition to making adjustments, these menus output continuous 4 mA or 20 mA and can be used as a signal test.

4.3.5 Remote Standby

Remote operation can be enabled. When the remote operation is enabled at the configuration settings (default: OFF), the CLX requires a 12-24VDC signal to begin operation of the CLX. When the signal is removed or turned off, the CLX goes into standby mode after the cycle is completed. Operation of this feature is covered in Section 7.7.



To prevent damage to the instrument, ensure that power is disconnected prior to making connections. For ease of connecting, remove the plug-in terminal block. Connections are labeled beside this termination on the PC board.

The recommended cable is 22 AWG shielded twisted pair. It is also recommended to crimp the wire with a ferrule (example: 9019000000) before inserting into the push to connect connector. To make a termination, simply crimp and push into the terminal.

4.4 Installing Reagents

The CLX will require that two reagents be installed prior to operation. These are a buffer and an indicator. Be sure the correct, prepared reagents are on hand as different reagents are required to read Free than Total chlorine residual. For reagent preparation refer to Section 10.3 *Replacing and Installing the Reagents*.



⚠ CAUTION

Use caution while preparing. The indicator reagent is corrosive and can stain clothing. Wear protective gloves, clothing and eye protection when replacing or installing the reagent kits.

5.0 Operation

The CLX Online Chlorine Analyzer allows for the measurement of the chlorine of process water on-line. The chlorine value of the process water is usually reported in milligrams per Liter (mg/L), these units are equivalent to Parts Per Million (PPM).

Readings above 10.00 mg/L are outside the range of this instrument.

5.1 Routine Measurement

First, ensure that all plumbing and electrical connections are complete before continuing.

The following steps describe how to measure the value of chlorine of a sample using this instrument:

1. Apply power to the instrument and allow the unit to warm up (typically 5 minutes). If this is the first time setting up the unit, the reagents will require priming. To do this, fill the provided syringe with the aggressive water, and insert the luer lock fitting on the end of the syringe into the tip of the reagent tube which is normally submerged in the bottles. Go into service mode to drain and shut down the analyzer. Apply steady but slow pressure to the syringe until it empties. You should see the water flowing into the measurement cuvette. Once this is completed, install your reagent set and press the prime button. If there is chlorine in the sample water, you should see pink water coming out of the drain by the end of the prime cycle.
2. When the instrument is operating continuously, it will display the measured chlorine level of the sample on the LCD screen. In addition, the equivalent signal is provided on the analog (4-20 mA) output, or the digital (RS-485) output, depending on the options selected.

During normal operation, the instrument will be in the home mode screen as shown below and continues to run a cycle repeatedly. The lower right message displays the state of the instrument in the current cycle. The lower left message displays the current state of the instrument. A cycle countdown timer is displayed in the middle of the lower banner. At the end of a complete cycle (countdown is 00:00), the reading is updated, and a new measurement cycle is repeated.



5.2 Security Access Feature

The instrument is equipped with a security access code feature that can be activated in the configuration mode. If the security feature is enabled, the screen shown in the illustration below will appear when the **MODE/EXIT** button is pressed.

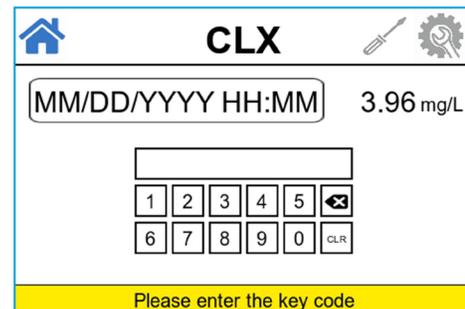

The security code must be entered to gain access to the main screen. The security code is 555555, then press ↵ button. It is not possible to change the security code.

If a valid access code has been entered, the instrument will be unlocked and redirects the user to the home screen. If the wrong access code is selected, the instrument will return to the home screen and continue its regular cycle. After 60s (1 minute) of inactivity (no buttons pressed), the screen will timeout and it will return to lock status. To unlock, the user must enter the security code. Refer to Section 7.5 *Enabling the Security Access for more information*.



5.3 The White LED

A white LED is used to illuminate the measurement cuvette for easy viewing of the instrument operations. During the Zeroing portion of the cycle and the Measurement portion of the cycle, when the green LED is active, the white LED is turned off to lower interference. This normal operation for the instrument and does not represent an error or problem.



The white LED is also used to draw attention to a problem as described in Section 9.0 *CLX Fault Detection*. In these instances, the white LED blinks at a constant rate dependent on the severity of the problem but is still turned off as described above. Please note that any fault is always posted to message queue on the lower portion of the LCD.

6.0 Instrument Calibration

HF scientific tests the product before it leaves the factory. The instrument operates from a pre-determined calibration curve for high accuracy of residual oxidant concentration. It is not necessary to recalibrate to maintain accuracy specifications.

If re-calibration is required by a regulatory authority, this can easily be performed. The method is by comparison against another instrument, such as a laboratory or handheld photometer (such as HF scientific's Chlorine Pocket Photometer).

There are two types of calibration. The slope and the zero. To perform the zero calibration, the instrument must be plumbed to a sample of known chlorine free water, such as de-ionized water for a zero adjustment. A zero calibration is not recommended.

Re-calibration of instrument may be required when operating at higher PPM (extended range = ON). If the CLX displays a CAL error or the calibration was incorrectly performed, it may be desired to restore the factory calibration. Navigate to the Restore Factory Cal to restore calibration to factory values. Note: Restore factory cal does not impact instrument settings

6.1 Slope Calibration Procedure

It is important that the chlorine level be quite stable to use this method. The comparison will be made against a trusted measurement such as a chlorine pocket photometer, spectrophotometer, or an amperometric titration.

1. Obtain a sample of the water.
2. Measure the value of the sample with one of the methods shown above.
3. On the CLX, go into service mode, and select user calibration. Then select slope calibration. Note: Ensure that a chlorine measurement cycle has been completed by the CLX. Ensure the comparison sample is taken at the CLX

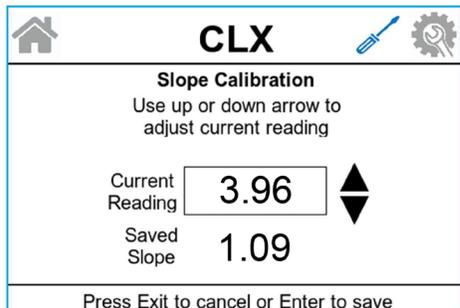
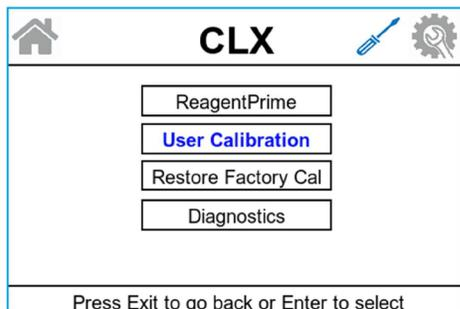

4. The screen will show the current reading on the CLX. Using the ▲ and ▼ buttons adjust the reading to agree with the laboratory method or portable chlorine photometer.
5. Press ↵ to accept the calibration adjustment and return to **AUTO** measurement mode.

NOTICE

There is a limit to the size of the change that can be made to a current reading. The upper limit is the current reading times 1.5. The lower limit is the current reading divided by 1.5.

Ensure a reading is posted to the display before calibrating to avoid an error.

6.2 Zero Calibration Procedure

Generally, this calibration is only required if readings are expected to be below 1 mg/L or if it is required by a regulatory authority. To perform this calibration, the water supply to the CLX must be changed to chlorine free water such as de-ionized water. **This chlorine free water must be run through the instrument for at least 3 cycles prior to using the following procedure.**

1. On the CLX, go into service mode, and select user calibration. Then select zero calibration.

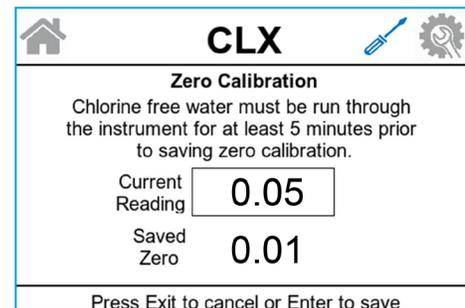
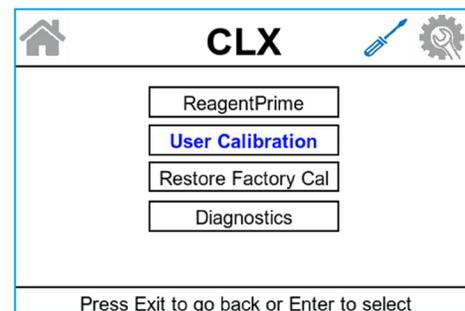

2. The screen will show the current reading on the CLX. Since there is no chlorine, the only reading may be a slight offset due to the absorbance of the reagents. There should be no pink color developed.
3. Press ↵ to perform a Zero calibration. When the calibration has completed the instrument will return back to the main service screen. Press Exit button to return to home screen.

NOTICE

There is a limit of ±0.20 mg/L total adjustment available. A ZERO Cal. greater than this will cause a CAL warning and no calibration will have occurred. Enter SERVICE mode to clear this error.

6.3 Restore Factory Settings

Factory reset restores the equipment settings to default values. Factory reset does not restore calibration.

All factory defaults including factory configurations can be reset by going into the config – factory reset. Press Enter to select factory reset.

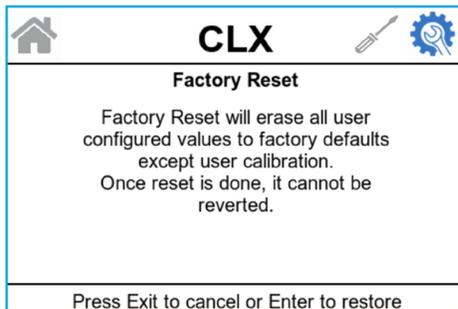
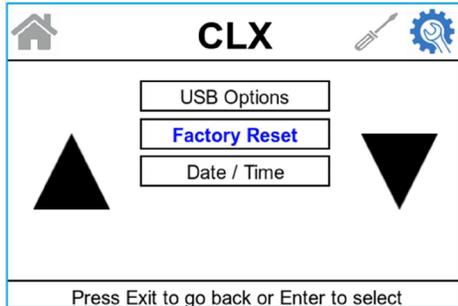

7.0 Instrument Configuration (CONFIG mode)

The instrument has been designed to provide the ability to customize the instrument according to needs at any time during normal operation. This mode has sub-menus to facilitate the different instrument configurations. This section describes how to use each of the sub-menus to configure the instrument. While in the configuration mode, the instrument has a time-out feature that automatically returns the system operation to the **Home** screen after five (5) minutes of screen inactivity.

NOTICE

Enter the **CONFIG** mode of the instrument by pressing the **MODE** button until the configuration icon is illuminated as shown below.

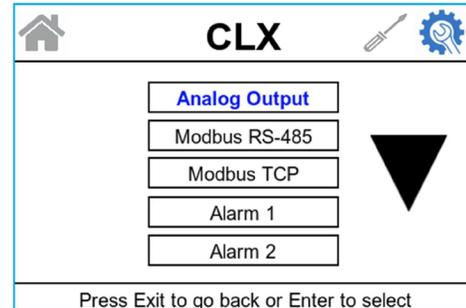

NOTICE

To exit the **CONFIG** mode, press the **EXIT** button. There is a timeout of 5 minutes of no activity in any config screen (except the USB firmware update and error log download) to bring the screen back to the **HOME** screen.

7.1 Setting the 4-20 mA Output

Select **On** or **OFF** using the ▲ and ▼ buttons. Once the desired analog output option has been selected, press the ↵ button to accept it. The next prompt will depend on the output selected. Also see Sections 7.2 and 7.3.

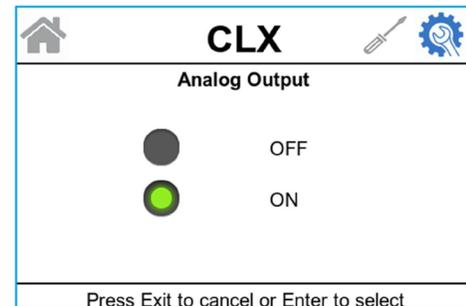

If the 4-20 mA output was set to **On**, the next screen prompts to set the 4mA and 20mA chlorine limits, calibration adjustment and error level.

Select the chlorine level to assign to the 4mA using the ▲ and ▼ buttons. Once the desired level has been set, press the ↵ button to accept it.

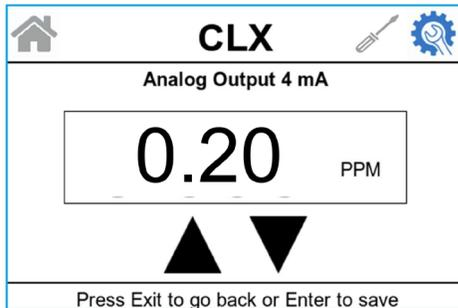
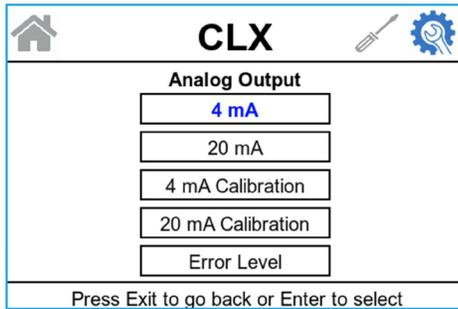

NOTICE

The next prompt is the chlorine level assigned to the 20mA. Select the chlorine level using the ▲ and ▼ buttons. Once the desired level has been set, press the ↵ button to accept it.

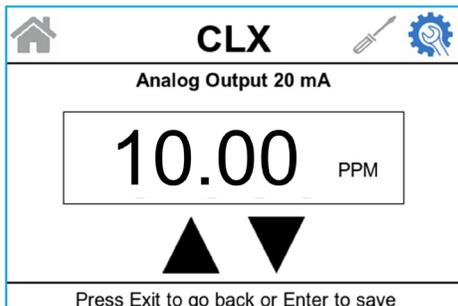
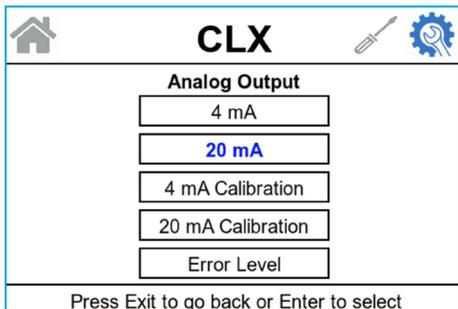

7.2 4mA Calibration Trim Adjustment



This adjustment allows the operator to make the CLX agree with a PLC or SCADA system. The adjustment limits are ± 200 counts or about ± 0.2 mA.

This setting will be slightly different on each instrument as each CLX will be factory set to 4.00mA. Select the 4mA Calibration, make adjustment using the ▲ and ▼ buttons. Press the ↵ button when adjustments are complete to save this setting and move on to the 20mA adjustment.

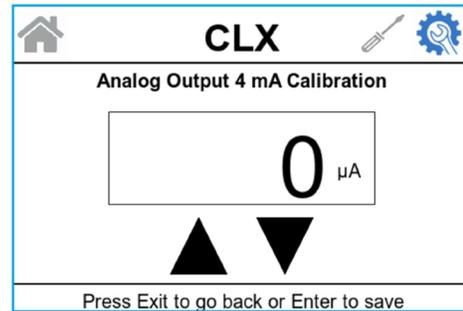
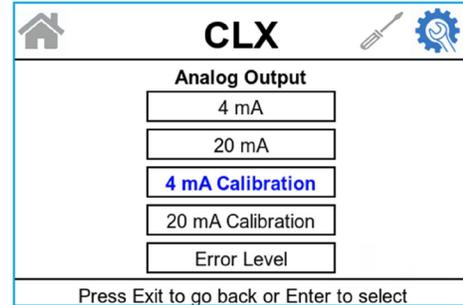

7.3 20mA Calibration Trim Adjustment

This menu operates similar as the previous menu. This menu outputs a constant 20 mA while allowing for a small amount of adjustment. The adjustment can be made using the ▲ and ▼ buttons. The adjustment limits are ± 1000 counts or about ± 1 mA.

This setting will be slightly different on each instrument as each CLX will be factory set to 20.00mA. When complete with the 20mA adjustment, press the ↵ button to accept and save all configuration settings.

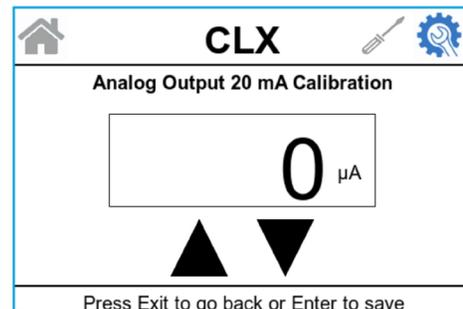
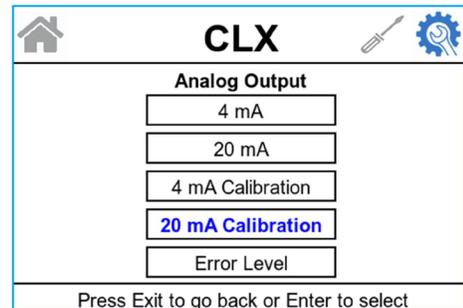

7.4 Configuring the Error Level

In case of an error in the CLX, the 4-20 mA reading can be used to indicate a problem by sending the current to either 4.00 mA, 2.00 mA or 0 mA. The factory default setting is OFF. Select the desired Error Level by using the ▲ and ▼ buttons then press the ↵ button to accept the desired error response.

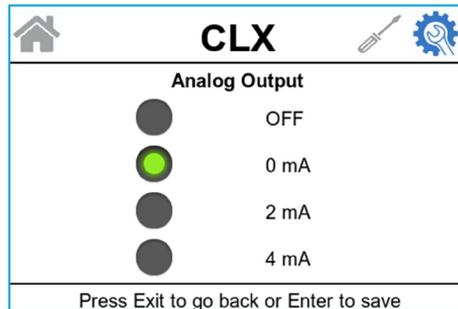
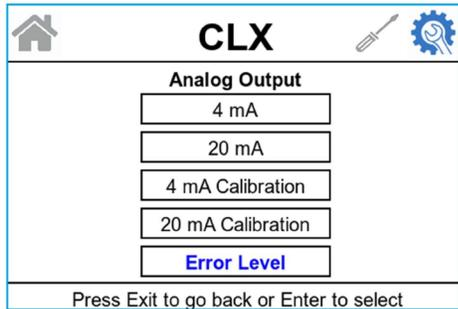

7.5 Configuring the Modbus RS-485

The instrument is equipped with an RS-485 Modbus port. Prompts will appear for setting the baud rate, and the address. The CLX RS-485 Modbus functions in RTU mode, stop bit of 1 and no parity.

Select the correct baud rate (2400, 4800, 9600, or 19200) for operation of the I/O port by pressing the ▲ or ▼ buttons to change the displayed baud rate and address. Press the ↵ button to accept selection.

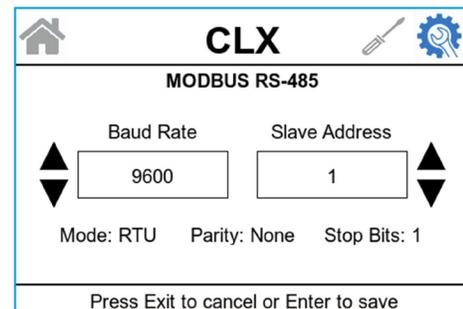
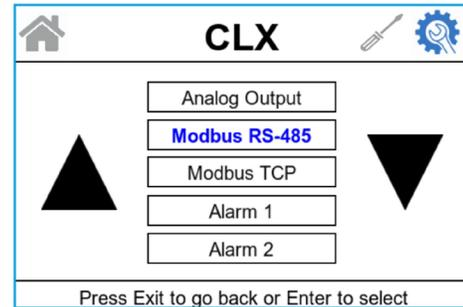

Refer to the Modbus Manual available from HF scientific or online at www.hfscientific.com.

7.6 Configuring the Modbus TCP

The instrument is equipped with Modbus TCP port. The operator can select Auto or Manual mode. In Manual mode, the operator must specify the Subnet Mask, IP address and Gateway address.

It is required to reboot the instrument upon setting of the Modbus TCP so that the settings can take effect. The screen will instruct user to press Enter to reboot. If you wish to cancel and change other settings, press Exit. To manually reboot the CLX, press the Left + Exit button simultaneously. Note: In manual mode selection, the user is also required to set the IP address on the receiving device (e.g.: Laptop) to manual mode with an assigned IP address and subnet mask. (e.g.: 192.168.0.2 and 255.255.255.0). This IP address cannot be the same as the CLX instrument Modbus IP address (e.g.: 192.168.0.1).

When the Auto mode is selected, after the selection, the user is required to reboot the instrument so that the settings can take effect. Return to the Modbus TCP Auto mode and select the IP Address and Port. Take note of the assigned IP address and Port and use the information to connect to the Modbus Poll or other relevant Modbus software program to use the assigned IP address and Port. Note: Auto mode selection requires connection to a DHCP server (e.g.: Router) that can auto assign an IP address.

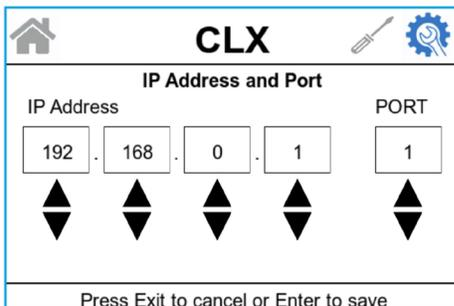
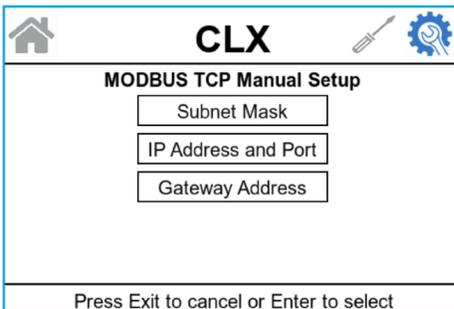
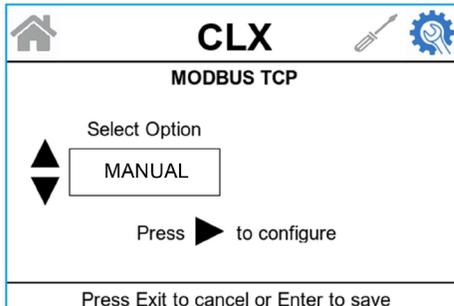
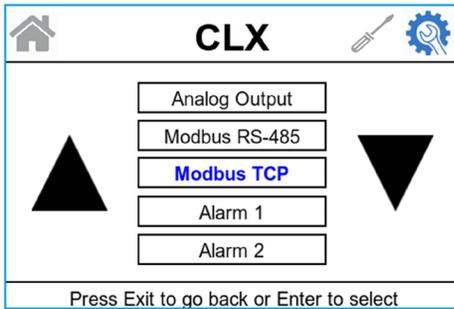

7.7 Configuring the Alarms

Two form C relays are provided that are designed to operate as two independent programmable alarms or as a system problem alarm. Please note that changes to alarms will not be recognized until the start of the next cycle. Both settings must be selected to fully program each alarm:

1. The alarm Mode (ON, OFF, Error or SVC ALM)
2. The alarm Set Point (level at which the alarm activates)

These items are described below:

Alarm Mode: The alarms can be set to either ON, OFF, Error or SVC ALM.

1. ON
 - a. High set point: the relay changes state when the measured chlorine level is higher than the programmed alarm level (set point).
 - b. Low set point: the relay changes state when the measured chlorine level is lower than the programmed alarm level (set point).
2. Error alarm: If there is a system fault or problem the alarm will change states.
3. SVC ALM: When Service mode is entered, the alarm will trigger regardless of an ERROR or no ERROR. If there is a system fault or problem, the alarm will change states.
4. OFF – The relay for the alarm is not affected.

Mode	Normal Operation		Service Mode	
	Error Occurred	No Error	Error Occurred	No Error
OFF	0	0	0	0
ON	Tied to PPM Set points	Tied to PPM Set points	Tied to PPM Set points	Tied to PPM Set points
Error	1	0	1	0
SVC ALM	1	0	1	1

1 = ALARM ON (NO/COM)
0 = ALARM OFF (NC/COM)

Alarm Set Point: The level at which an alarm activates is called the alarm set point. The set point is adjustable to any valid chlorine level within the range of the instrument in steps of 0.01 mg/L. This setting is not available if the Error function is chosen.

7.7.1 Alarm 1

Alarm 1 Mode: The Mode indicates the current function of Alarm 1 (**ON, OFF, Error or SVC ALM**). Use the ▲ or ▼ buttons to cycle through and select the desired function. Press the ↵ button to accept the selection.

Alarm 1 Set Point: This prompt is used to select the set point for this alarm when Alarm is in the ON state. Select the desired alarm level by using the ▲ and ▼ buttons. Once the desired set point has been set, press the ↵ button to accept it.

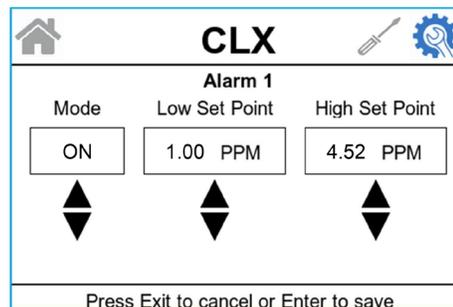
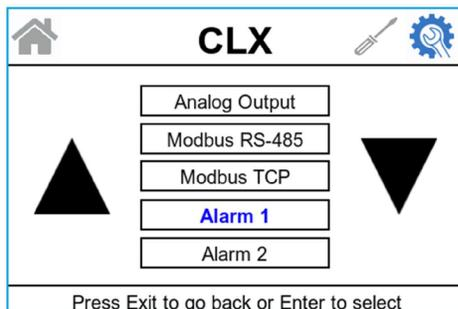

7.7.2 Alarm 2

Repeat the procedure listed in Section 7.7.1 to set up the parameters for alarm 2.

NOTICE

Due to the cyclic nature of the CLX, relay chatter is not an issue. There is no need for alarm delays or hysteresis.

7.8 Remote Standby

When the remote standby is enabled (ON), the CLX instrument requires a signal on the remote port to start taking a measurement cycle. The acceptable signal level is 12-24VDC. Once the acceptable signal level is provided, the CLX instrument will continue taking the measurement. The default for remote standby is set to OFF state. When the remote standby is in the OFF state, the CLX instrument will automatically start taking measurements continuously without requiring external trigger.

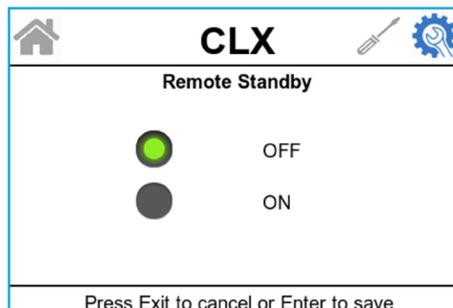
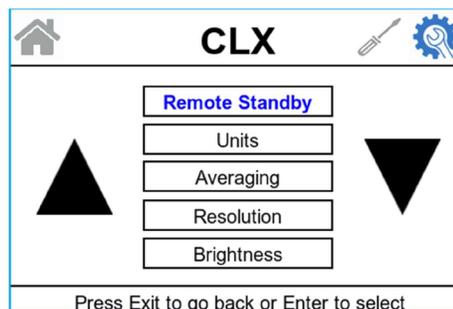

7.9 Units of Measurement

The unit of measure can be set to mg/L (milligrams per liter) or PPM (parts per million). The factory default setting is mg/L. Select the desired UNIT using the ▲ and ▼ buttons and press the ↵ button to accept it.

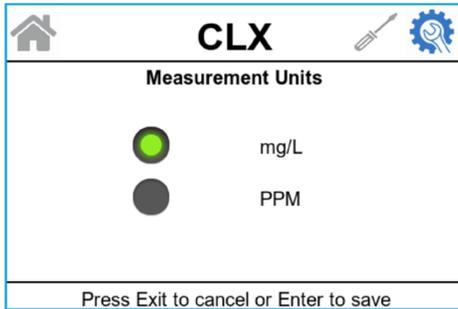
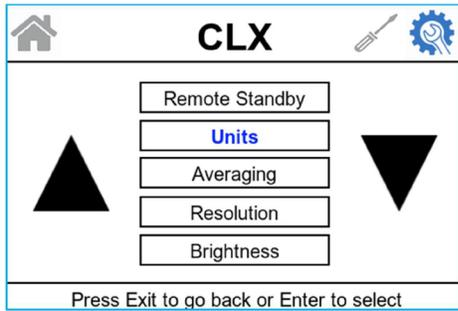

7.11 Resolution

The CLX can display readings up to 3 decimal placements. The default factory setting is 2 decimal placements.

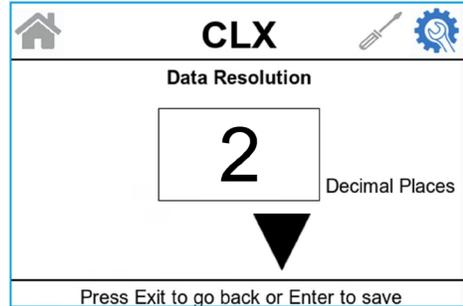
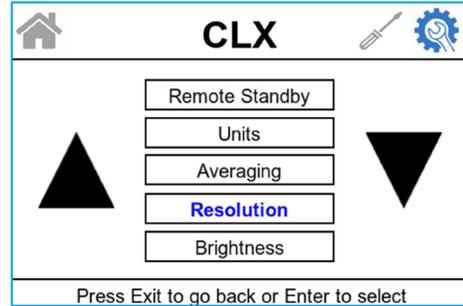

7.10 Averaging

The CLX can display and output averaged readings to help smooth out the response and eliminate large reading variation in rapidly changing processes. There are 5 settings for the averaging feature:

- 1 = No averaging, each reading is in "real time".
- 2 = The current reading and previous reading are averaged.
- 3 = The current reading and previous 2 readings are averaged.
- 4 = The current reading and previous 3 readings are averaged.
- 5 = The current reading and previous 4 readings are averaged.

The default factory setting is averaging of 1. Select the desired averaging point using the ▲ and ▼ buttons and press the ↵ button to accept it.

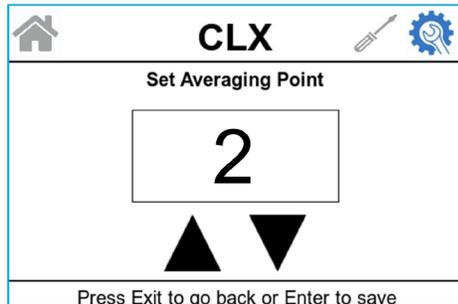
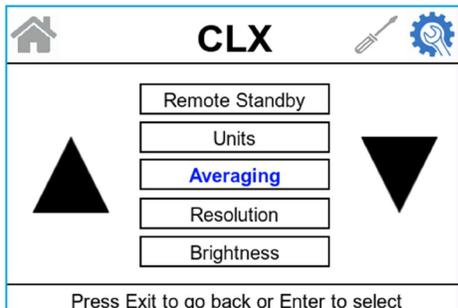

7.12 LCD Backlight Brightness

The LCD backlight brightness can be adjusted. Ten levels of brightness are available. The default factory setting brightness is 8. Change the brightness by pressing the ▲ or ▼ button. When the desired brightness has been selected, press the ↵ button.

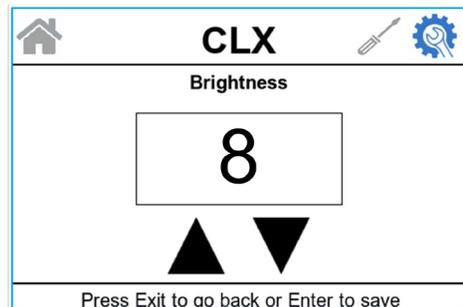
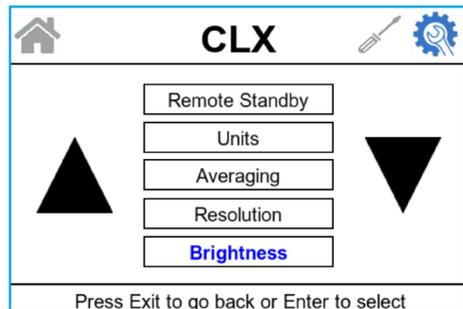

7.13 About Device

Click About Device to get the current software version and the build date of the software.

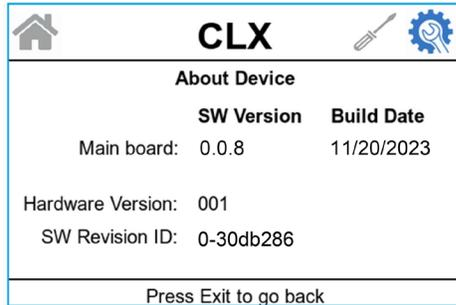
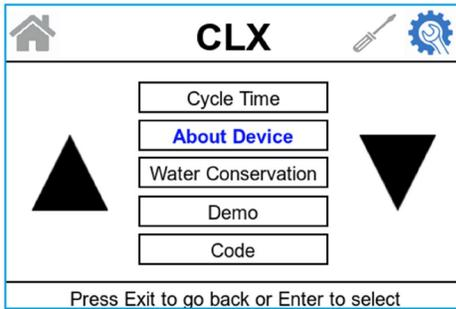

7.14 Water Conservation

To conserve water, the flush time during post wash can be adjusted to use as little water as possible.

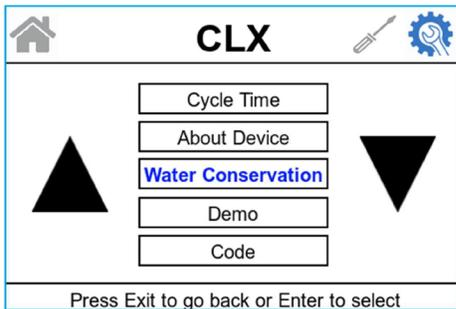

When the **water conservation** is turned **On**, at the factory cycle time the instrument omits a wash cycle after completing the sample measurement. This results in reduced cleaning of the cuvette (post wash). The actual amount of water conservation is dependent on the incoming water pressure and the cycle time setting. The default factory setting for this option is **OFF**. Make selections using the ▲ and ▼ buttons then press the ↵ button to accept the setting. To achieve low cycle time (example 60 seconds cycle time), ensure that the water conservation feature is set to ON.

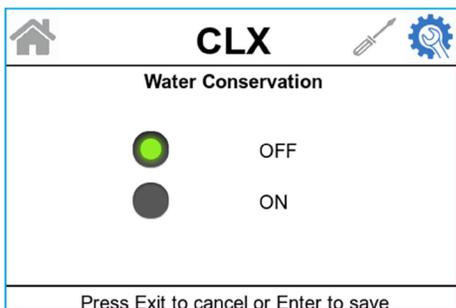

7.15 Code / Enabling the Security Access

The instrument is equipped with a security access. If this option is turned on, the user is required to input the access code into the instrument to get to any mode other than **AUTO**. The code is **555555**. This code cannot be changed. See Section 5.2 for more information on this security feature. The default setting for the code is set to **OFF**.

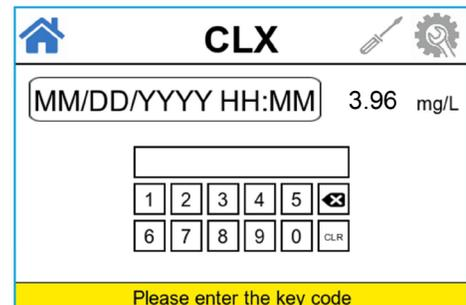
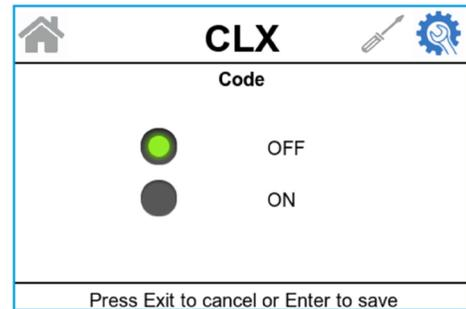
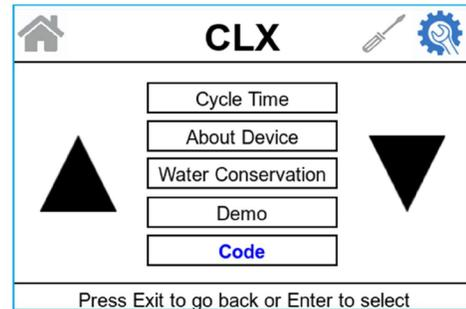

7.16 USB Options

The CLX has a type-C USB. The USB option allows user to perform firmware update or to download data / error logs. Insert a USB type C into the instrument and follow the instructions to either update the firmware or download the data or error log. Faulty or invalid measurements (errors related to water intake, reagent, drain, green LED, red LED, or chlorine computation from absorbance) are added to the error log.

When upgrading the software, only have one firmware on the root directory of the USB drive. The file should have the word "FIELD" in the file name (e.g.: *CLX2-FIELD-v0.0.9-0-b82da21.bin*).

Note: User calibration information is stored in the EEPROM in a non-volatile memory, so it is not impacted when firmware upgrade or factory reset is performed.

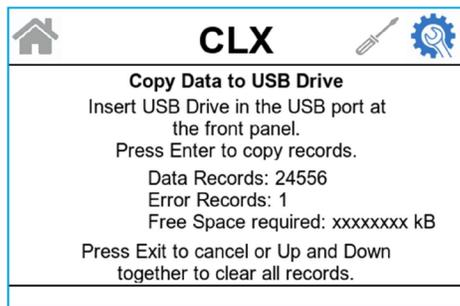
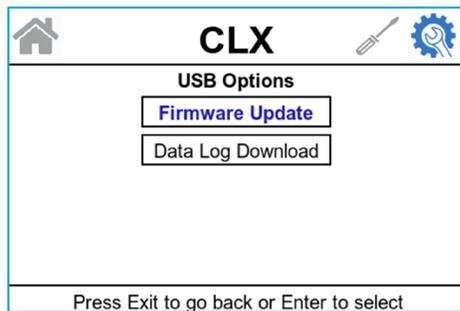
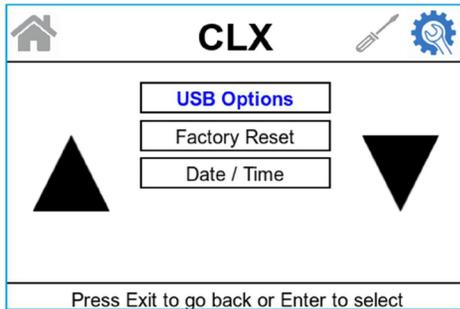

7.17 Date / Time

The Date and Time of the instrument can be set by going into the configuration menu and selecting date / time. Make adjustment and save the setting by pressing ↵. The time is in 24hr format.

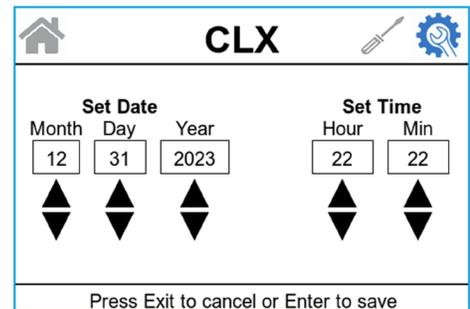
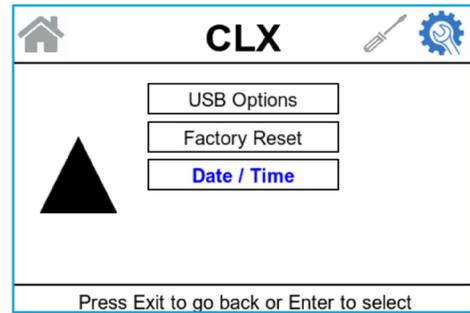

7.18 Instrument ID

The instrument ID can be set by going into the configuration menu and selecting the Instrument ID option. Instrument identification is useful for identifying data/error log for multiple CLXs. When the data or error log file is downloaded, the first six digits of the filename corresponds to the instrument ID. Make adjustment to the ID name and save the setting.

Note: Instrument ID is stored in the EEPROM in a non-volatile memory, so it is not impacted when firmware upgrade or factory reset is performed.

Name	Date modified	Type	Size
123456_data_log_2024-02-20_10-19-11.c...	2/20/2024 3:54 PM	Microsoft Excel Co...	232 KB
123456_error_log_2024-02-20_10-19-17.c...	2/20/2024 3:53 PM	Microsoft Excel Co...	2 KB
CLX2-FIELD-v0.1.3-0-bf9ca82.bin	3/8/2024 9:10 AM	BIN File	2,041 KB

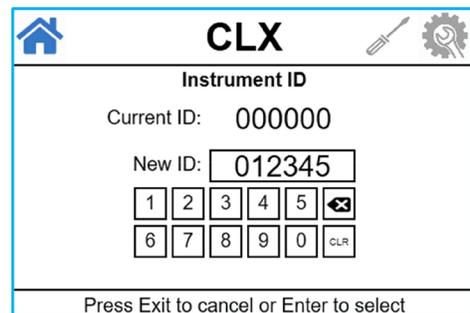

7.19 Extended Range

The extended range can be set by going into the configuration menu and selected ON. The extended range by default is OFF. The extended range allows higher range PPM measurement. When it is set to ON, it allows up to 15 PPM measurement range.

Re-calibration of instrument at a higher ppm may be required when operating above 10 PPM.

OFF : 0 – 10 PPM

ON : 0 – 15 PPM

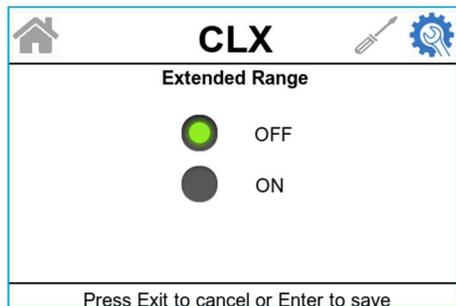
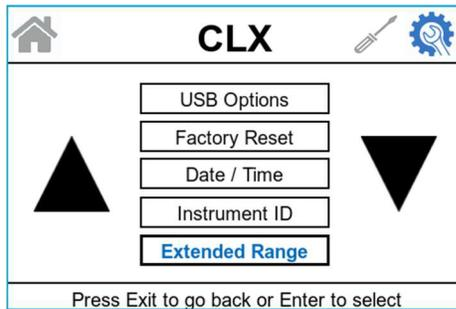

8.0 Additional Features and Options

8.1 Modbus Communication

Modbus protocol communication manual is available HF #24569. This manual is available free online at www.hfscientific.com. Type 24569 in the search bar to get the manual.

8.2 Desiccant Cartridge Option (Catalog #09944)

An optional desiccant cartridge kit can be purchased for use in applications where condensation on the glass cuvette may compromise accuracy. The desiccant changes color from blue to tan when expended. Instructions for replacement are included with the kit.

9.0 Troubleshooting

9.1 CLX Fault Detection

The CLX performs continuous diagnostic monitoring. In the CLX, there are 4 severity levels of fault detection. Level 4, and 3 will allow normal operation but warn of the problem. Level 1 is an instrument failure, and the instrument will not operate. Level 2 will allow the instrument to continue operation, but the measurement results may be faulty or not logged. Any faults are displayed in a queue form in the bottom row of the LCD.

A **level 4 fault** is simply a screen indication that one of the alarm levels has been activated. This fault level will not affect the 4-20 mA and will only affect the alarm activated. The sample back light blinks at a rate of once every 4 seconds.

Level 4 (Self-Clearing) fault conditions

Message	Description of Fault	Corrective Action
Alarm 1 Triggered	Alarm 1 is enabled and triggered	None required. Information only
Alarm 2 Triggered	Alarm 2 is enabled and triggered	None required. Information only
Reading Over Range	Reading is over or under the set ppm range	None required. Information only

A **level 3 fault** indicates a failure or a problem that usually can be corrected by the operator. Refer to the chart below. If any of these errors occur, the instrument will still display readings and probably will operate correctly. These faults will self-clear when the problem is corrected. If any of these faults occur, they may affect the 4-20mA and any alarm dependent on fault detection setting (Error). See Sections 7.2 and 7.4.1 for error settings. The sample back light blinks at a rate of once every 2.5 seconds to indicate a level 3 fault.

Level 3 (Self-Clearing) fault conditions

Message	Description of Fault	Corrective Action
Calibration Adjustment Error	The calibration adjustment number is excessive	Repeat another user slope calibration. Check that the reagent bottles are not empty, and tubing is properly primed
Zero Calibration Error	Zero calibration reading more than 0.20mg/L	Use deionized water to flush and measure for at least 3 cycles
Drain Solenoid Error	Drain solenoid unable to turn on / off, or possible feedback damaged	Check the drain solenoid cable connection, use the Service-Diagnostic-Solenoid Testing screen to verify drain functionality
Draining Slow	During the purge cycle, the cuvette is draining slowly	Check the drain line and ensure it have a nice slope down and air gap, Check the optical board detector connection
Analog Loop Open	No electrical connection made on the analog output or bad connection	Check the 4-20 mA wiring or turn off 4-20mA analog output if not used (See Section 7.1)
Water Calibration Failed	Water calibration at startup failed	Check the intake water line for flow rate and pressure, Check the optical board detector connection
Water Fill Is Fast	Water filling in the cuvette too fast	Adjust the regulator counterclockwise. Use the flow measure in Service-Diagnostic screen; flow measure water pulse count must be more than 8 and indicate "GOOD"
No Water	No water when the intake solenoid is turned on	Check the intake water line for flow rate and pressure, Check the optical board detector connection. Ensure that the inlet flow line has a minimum of 5 lbs of pressure
Water Fill Is Slow	Water filling in the cuvette too slow	Adjust the regulator clockwise. Use the flow measure in Service-Diagnostic screen; flow measure water pulse count must be more than 8 but less than 22 and indicate "GOOD". Ensure that the inlet flow line has a minimum of 5# of pressure

A **level 2 fault** indicates a severe problem that will usually require technical assistance from HF scientific customer service (see Section 9.7). The sample back light blinks at rate of once every 1 second.

Level 2 fault conditions

Message	Description of Fault	Corrective Action
Green LED Failed to Turn On	LED / Optical board fault	Check the cable connection and then reboot instrument by holding down Left + Exit button. Use the Service-Diagnostic-LED / Noise Measure to test LED functionality. If failure persist, contact HF scientific
Green LED Failed to Turn Off	LED / Optical board fault	Check the cable connection and then reboot instrument by holding down Left + Exit button. Use the Service-Diagnostic-LED / Noise Measure to test LED functionality. If failure persist, contact HF scientific
Green LED Optimization Failure	LED / Detector / Optical board fault	Check the cable connection and then reboot instrument by holding down Left + Exit button. Use the Service-Diagnostic-LED / Noise Measure to test LED functionality. If failure persist, contact HF scientific
Red LED Failed to Turn On	LED / Optical board fault	Check the cable connection and then reboot instrument by holding down Left + Exit button. Use the Service-Diagnostic-LED / Noise Measure to test LED functionality. If failure persist, contact HF scientific
Red LED Failed to Turn Off	LED / Optical board fault	Check the cable connection and then reboot instrument by holding down Left + Exit button. Use the Service-Diagnostic-LED / Noise Measure to test LED functionality. If failure persist, contact HF scientific
Red LED Optimization Failure	LED / Detector / Optical board fault, no water	Check the cable connection and then reboot instrument by holding down Left + Exit button. Use the Service-Diagnostic-LED / Noise Measure to test LED functionality. If failure persist, contact HF scientific
Power On Self-Test Failed ##	Internal board issue	Contact HF Scientific
PSU Voltage Low	Internal board issue	Contact HF Scientific
No Power to Intake Solenoid	Internal board issue	Check the cable connection and then reboot instrument by holding down Left + Exit button. Use the Service-Diagnostic-Solenoid Testing to test functionality. If failure persist, contact HF scientific
No Power to Drain Solenoid	Internal board issue	Check the cable connection and then reboot instrument by holding down Left + Exit button. Use the Service-Diagnostic-Solenoid Testing to test functionality. If failure persist, contact HF scientific
No Power to Reagent Solenoid	Internal board issue	Check the cable connection and then reboot instrument by holding down Left + Exit button. Use the Service-Diagnostic-Solenoid Testing to test functionality. If failure persist, contact HF scientific

A **level 1 fault** is a system fault. This is NOT a problem that the operator can correct, and the unit must be returned to the factory for service (see Section 9.7). The display will show **the message in a red banner**. If this fault occurs, it will affect the 4-20mA and any alarm set for fault detection (Error). The instrument will not operate with this fault. The sample back light blinks at rate of once every 0.4 seconds.

9.2 Diagnostic testing

Access the diagnostic feature in Service mode to assist with setting the equipment, troubleshooting errors or failures, routine maintenance, and cleaning or with equipment storage.

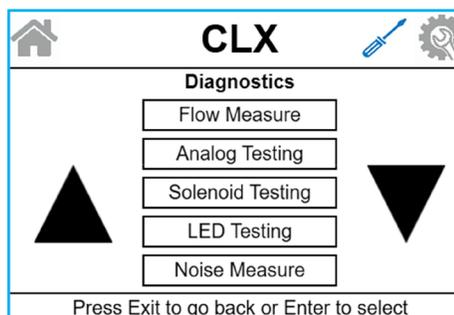
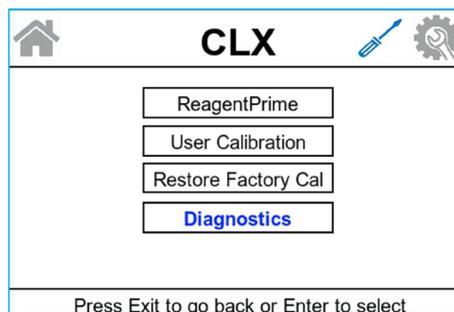

9.2.1 Noise Measure

Noise measure is a feature for the instrument to test the detector and how it reacts to the current environment. The returned value should be less than 0.500. If it is greater than 0.500, it could point to potential issue such as a damaged detector or green led on the optical board, a bad optical assembly cable, or a dirty or clogged cuvette (or cuvette that has scratches on them).

9.2.2 Flow Measure

Flow measure allows the user to determine the number of water pulses to fill a cuvette. The number of pulses depends on the flow rate of the incoming water and the pressure. The pressure regulator on the instrument can be adjusted to allow faster water pulses. A good flow measure is between 9 to 13 pulses. The recommended water pulses are to have it set at 10. The CLX instrument can certainly function at a low flow rate (up to 22 water pulses), this will require increased cycle time setting.

9.2.3 LED testing

Use the LED testing diagnostic feature to visually look at the incremental brightness of the green or red led. This feature is particularly useful to determine if the LEDs are functioning correctly or a form of predictive maintenance for cuvette cleanliness.

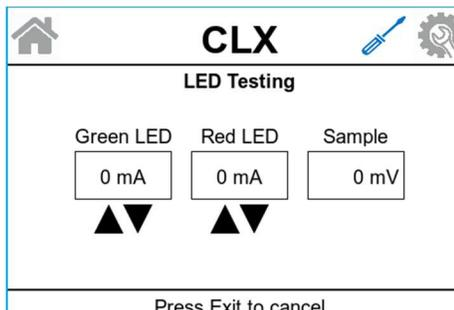

9.2.4 Solenoid testing

Use the solenoid testing feature to manually toggle the drain, intake, or reagent pump. This feature helps troubleshoot the operation of the solenoid pumps, and during cleaning or flushing of the cuvettes by manually toggling the pumps. Upon exit, it will default the solenoid to the OFF state. Do not leave the solenoid ON for more than 15s.

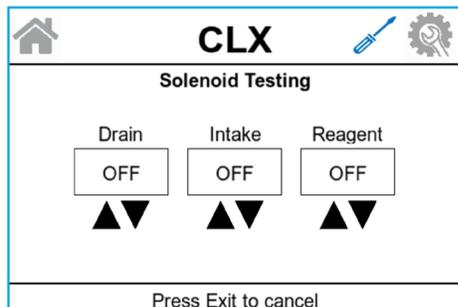

9.2.5 Analog testing

The analog testing allows troubleshooting of the analog output section. The analog output will put out analog current based on one of the settings selected; 0mA, 4mA, or 20mA. A simple test method is to use a multimeter in current measurement mode (DC). At 20mA, it is expected to be approximately $20\text{mA} \pm 5\%$.

9.2.6 Alarms testing

When the Alarm 1 is selected, then the NO and Common of Alarm 1 is activated, and Alarm 2 is inactive.

When the Alarm 2 is selected, then the NO and Common of Alarm 2 is activated, and Alarm 1 is inactive.

9.2.7 Environment

Displays the environmental temperature and humidity of the instrument.

9.3 Setting Flow Rate

The flow test will need to be run and the flow adjusted at installation and any time the analyzer is moved or the inlet pressure changes. Installation variances may affect the flow. The optimal flow rate through the CLX may be adjusted if needed. The flow is adjusted by removing the regulator vinyl cap and turning the adjustment screw on the pressure regulator. Refer to Figure 4. To assist in this adjustment, follow the procedure shown below:

1. Enter the service mode screen. This will cause the cuvette to drain.
2. Go into Diagnostic. Select Flow Measure. Press Enter.
3. The CLX will pulse the water intake to bring water into the cuvette. The number of water pulse continuous to increase until sufficient water is filled into the cuvette. A water pulse count of 9-13 is typical 10 is recommended.
4. The display will show one of three messages HIGH, LOW or GOOD and the measured flow count. A low flow rate is when the water pulse count is more than 22.

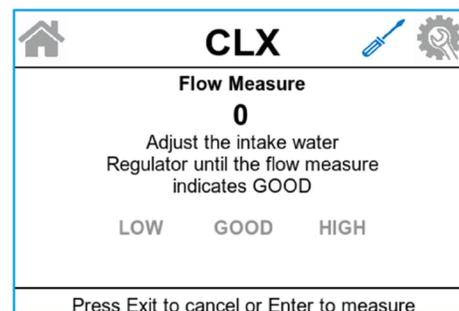
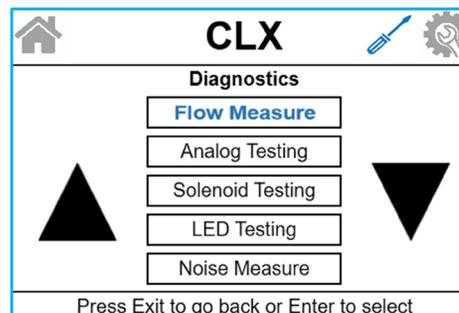

To adjust the pressure on the water regulator, loosen the locking nut then adjust the pressure regulator using a coin or a large flat blade screwdriver. Press enter to capture the water pulse count. Please note that only $\frac{1}{4}$ turn incremental adjustments should be made to the regulator on each attempt.

If the message is LOW, turn the regulator clockwise. If the message is HIGH, turn the regulator counterclockwise. The optimal flow is 9-13. The analyzer will allow you to function at 8-20, but cannot take big pressure swings at these levels. Tighten the locking nut after adjustment and replace the regulator vinyl cap. To return to normal operation, press the \leftarrow button followed by the Exit button to return to the normal Home screen mode.

9.4 Clearing Faults

Every time **SERVICE** mode is exited, all faults are cleared. If the original fault or a new fault occurs, it will be posted.

9.5 Reagent Clogs



If reagents fail to flow or prime it may be due to a clog in either the tubing or at a check valve. To alleviate this, you may have to flush the system with chlorine free water, preferably deionized water. See Section 10.4 Check Valve Flushing Kit.

9.6 Diagnostic Chart

Symptom	Cause	Cure
Lower display shows Analog Loop Open	4-20 mA loop open	Check wiring. See Sections 4.3.4 and 7.1. Turn off analog output 4-20mA setting if not used
Lower display shows POST	System fault	Refer to Section 9.1. Contact HF scientific
Readings are erratic	Bubbles in solution Debris in flow or cuvette	Refer to Section 9.1. Install T-strainer at inlet
Readings are lower than expected	Condensate or leaky measurement cuvette. Measurement cuvette dirty, Reagents bad or expired, Buffer reagent not being dispensed	Install desiccant cartridge kit Replace or clean cuvette. Replace reagents Check buffer lines and check valves. Flush tubing (use kit #25096) with deionized water and perform priming. Perform user calibration.
Readings are higher than expected	Bad calibration, high concentration of sample	Perform user calibration. Confirm with a secondary chlorine measurement device such as the pocket photometer
Instrument displays Water Fill Is Slow or Water Fill Is Fast	Water pressure or flow rate need adjustment	Go to Service mode and perform flow measure test. Adjust the water regulator so that the desired flow measure water pulse counts are between 9-13.
Instrument displays Water Calibration Failed or No Water	Water was not running when power was applied.	Ensure water is turned on. Then go to Service mode, then press the Exit button. This will force the instrument to initiate a new reading cycle. If no water was previously applied, such as during a maintenance schedule, the instrument will automatically retry a cycle in 60 minutes.
Instrument will not prime	Check if check-valves are clogged or bad	Try using the supplied check valve flush kit (syringe) or a squeeze bottle filled with non-chlorinated water. (1) Soak check valve in non-chlorinated water for 2-3 hours. (2) Install 25017S check valve replacement kit Use the Diagnostic screen to test the reagent solenoid functionality. Ensure that the tubing is not pinched against the front of the bottle with the door closed The check valves or duck bills may need to be changed in the manual Check the suction tubing which goes through the bottle cap has not been kinked Check that the suction tubing submerged in the bottle is not floating or kinked

9.7 Technical and Customer Assistance

If for any reason assistance is needed regarding this instrument, please do not hesitate to contact either the HF scientific Technical Service Department or the HF scientific Customer Service Department:

HF scientific

16260 Airport Park Drive, Suite 140

Fort Myers, Florida 33913

Phone: (239) 337-2116

Fax: (239) 454-0694

Toll Free: 888-203-7248

Email: HF.Info@Wattswater.com

www.hfscientific.com

10.0 Routine Maintenance / Servicing

10.1 Normal Maintenance Schedule

The recommended schedule is shown below. It is important to replace the reagents monthly to get reliable accurate readings from the CLX.

The CLX is shipped with one CLX Tubing/Cuvette kit, HF part # 09950. The kit consists of the following:

Qty	Part
2	Cap Assemblies
8	Pump Tubes
1	Cuvette

Two complete cap assembly sets are used in the CLX: one for the buffer and one for the indicator.

The supplied kit is intended to last for one year. Additional kits can be ordered from your local HF scientific distributor or representative. It is recommended to keep one kit on hand at all times.

Generally, all pump tubes should be replaced every 6 months. The Cap assemblies should be replaced annually.

NOTICE

Every Month

1. The reagent required for operating this instrument must be changed on a monthly basis (with a 2.5 minute cycle time).
2. The external strainer should be checked and cleaned regularly.
3. The glass cuvette should be inspected. Check for excessive debris on the inside surface of the glass. Clean and or replace the cuvette as necessary.

Flushing the System

It is recommended that the tubing replacements be timed with reagent replacement. Press the Mode button to enter the Service screen. This will stop the water flow. Navigate to the Diagnostics screen and manually toggle the intake and drain from off to on and back to off to flush the cuvette. Remove the old reagents and discard. Place the inlet tubing in a small container of clean water. See Section 9.2 for more information using the Diagnostic testing feature.

NOTICE

Upon exiting Service mode, the CLX will automatically initiate a water zero calibration and start to perform a cycle.

Annual Pump Tubing Replacement

The pump tubing may need replacement more often because they are subject to wear from the reagent "Pump". The check valves should not need to be replaced and should be saved. Please note that the check valves are directional and that the "IN" side is smaller in diameter (see Figure 8).

Steps:

1. Flush the system as described above to reduce personal contact with the reagents.
2. Navigate to the service screen to stop the flow of sample water and drain the cuvette by going into the diagnostic.
3. Remove and retain the thumb screw on top of the pump; pull the pump hammer and spring up and out of the way. There is no need to completely remove the hammer and spring.
4. Working on one reagent side at a time. Replace the black pump tubing between optics inlet and the check valve OUTLET. Discard the old tubing.

5. Ensure the check valve is placed into its seat in front of the pump assembly.
6. Repeat steps 4 and 5 for the other reagent.
7. Replace the hammer and spring back into place and secure with the thumb screw.
8. See Figure 8 to ensure correct installation.
9. Return to operation as described.

Cap Assembly Replacement

The Cap Assembly can be changed as needed. Check the condition of the buffer and indicator cap bottle and change if it appears badly soiled or discolored. Use HF part # 09950 for replacement.

NOTICE

Cuvette Replacement

To replace the cuvette, first navigate to the Service screen. Use the Diagnostic feature to drain the flush and drain the cuvette. For example: Turn on the intake, turn on the drain. Repeat.

Check the condition of cuvette and change if it appears badly soiled or discolored. Follow the steps below:

1. Turn the knurled top on the optics system counterclockwise (as viewed for the top) until the cuvette just "pops" out, but do not remove the top.
2. When the cuvette "pops" out, move the retaining O-ring and remove the cuvette. You may need a stiff wire such as a bent paper clip to grasp the cuvette. Retain this cuvette for future use if it can be cleaned.
3. Install the new or clean cuvette by pushing it firmly in place and turning the knurled top clockwise until the cuvette is held securely.
4. Check the drawing on the following page to ensure correct installation.
5. Return to operation as described.

Return to Normal Operation from Service

Press the Exit button to return sample flow to the system. Check for leaks. If a leak occurs, enter the Service screen, repair leak and repeat the process. Once the system is operating correctly, reinstall reagents and then enter Service screen and use the reagent priming option to restart reagent flow. After the reagents are primed, click the Exit button to return to the Home screen. The system will automatically return to normal operation.

NOTICE

Tubes may darken due to contact with the reagent. This is an expected condition and does not affect the performance of these parts.

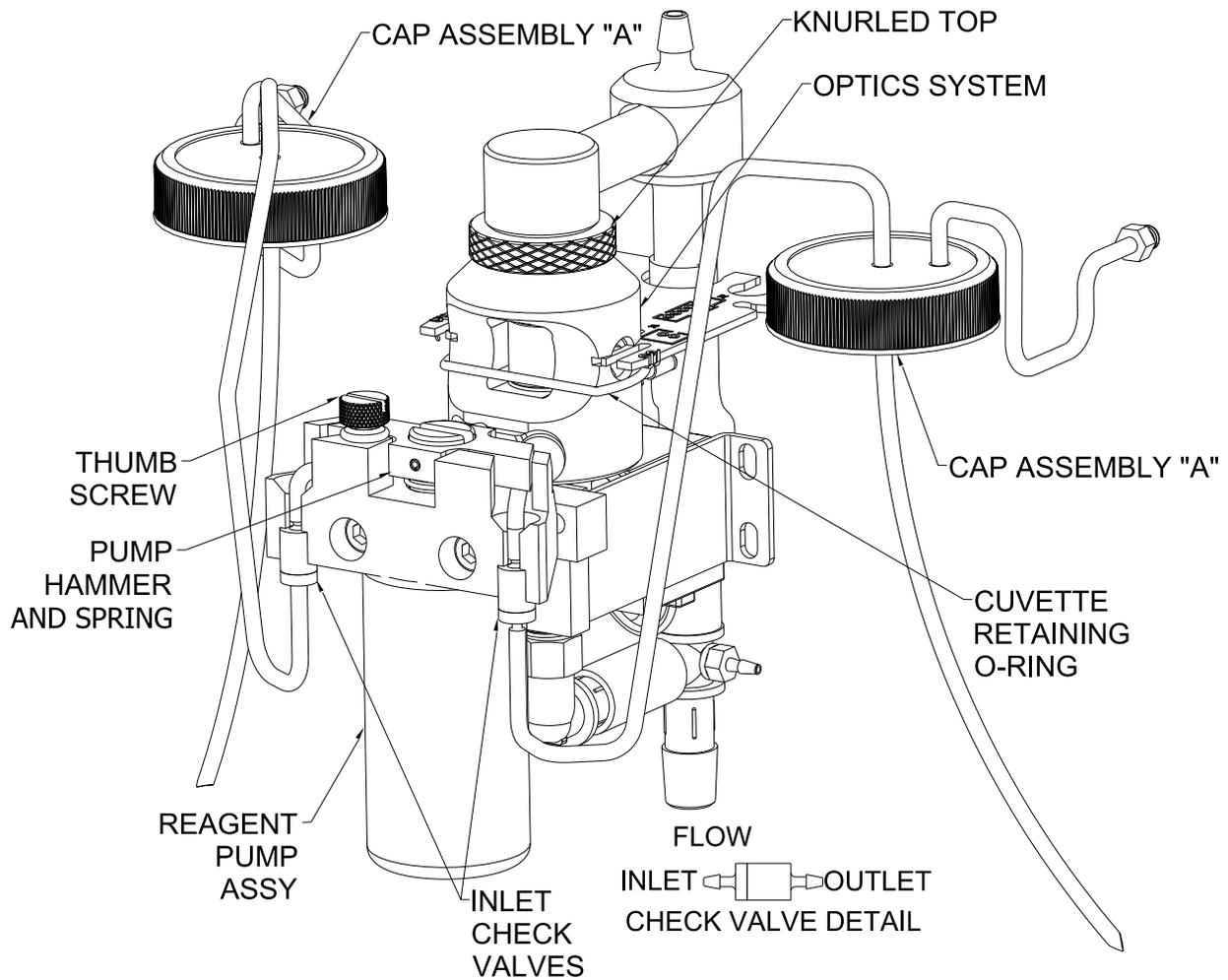

Figure 8: Reagent Tubing Installation

10.2 Preventative Maintenance Schedule

To ensure the instrument will operate reliably, some sites may wish to implement preventative maintenance. The proposed schedule is shown below:

Procedure	Maintenance Period	Detail
Change Reagents	Once per month	See replacement parts list Section 11
Check Cuvette	Once per month	Clean or replace if needed
Check T-Strainer Screen	Once per month	Clean or replace if needed Cat# 28145S
Replace Pump Tubes	Once every six months	Included with Tubing/ Cuvette Kit
Replace Cap Assemblies	Once per year	Tubing/Cuvette Kit Cat # 09950
Replace Check Valves	Once per year or as needed	Check Valve Kit Cat # 25017S

Follow the enclosed procedures with any of the kits or parts mentioned above.

10.3 Replacing or Installing the Chassis Assembly

If the chassis assembly requires replacement or upgrading, use the following steps to remove the current chassis assembly to perform the replacement. Note: The Chassis assembly catalog part # is 110230S. Please provide this number when ordering for replacement.

Steps:

1. Disconnect / Remove AC main power to the chassis assembly, see Section 4.3. Remove the buffer and indicator bottles so that there is more room to work with.
2. Disconnect any other user interface cables such as Alarm 1, Alarm 2, Modbus, etc....
3. Remove the fasteners that is securing the current chassis assembly in the instrument. Keep the fasteners so it can be used for the replacement chassis assembly.
4. As the chassis assembly is removed from the instrument, the interconnect cables must be disconnected. Disconnect the following interconnect cables,
 - a. Intake pump cable (2 wire, red color wires)
 - b. Drain pump cable (2 wire, black color wires)
 - c. Reagent pump cable (2 wire, black color wires)
 - d. Optical board LED wires (6 cable wires)
 - e. Optical board detection wires (2 cable wire)

Note: Do not disconnect the cable / wires from the PCBA.

5. Take the replacement chassis assembly, and connect the interconnect cables; intake, drain, reagent, optical board.
6. Secure the chassis assembly to the instrument with the fasteners.
7. Reconnect the user cables such as Alarm 1, Alarm 2, Modbus etc....
8. Reinstall the buffer and indicator bottles. Consult Section 4.3 for reconnecting AC main power to the chassis assembly.
9. As the equipment powers back up and reinitializes, perform the normal instrument setup.
 - a. Setup the date/time and instrument ID if required.
 - b. Adjust user settings to desired. See Section 7 for Configuration setup.
 - c. Perform reagent priming by going into Service screen.



10.4 Replacing or Installing the Reagents



Reagent kits are available from HF scientific for Free Chlorine and for Total Chlorine, refer to Section 11.0 *Replacement Parts and Accessories* for the appropriate Catalog numbers. There are two reagents required, and supplied in each kit; the buffer and the indicator.

1. Press the Mode button to enter the Service screen then press enter to accept. This will empty the cuvette and stop any flow of water.
2. Remove the existing reagent bottles from the CLX.
3. Fill the provided syringe with aggressive water (RO, Deionized, or distilled), and insert the luer lock fitting on the end of the syringe into the tip of the reagent tube normally submerged in the bottles. Apply steady but slow pressure to the syringe until it empties. You should see the water flowing into the measurement cuvette. Complete this step for both reagent tubes. (Buffer and Indicator)
4. Reagent Kits are available in a premixed liquid kit or in a Dry (powder) form that requires the addition of aggressive water. You will need to have at least 1 liter of aggressive water on hand before preparing the solutions. Allow about ½ an hour for the reagents to fully dissolve.
5. For the Dry J.A.W. reagent kit, follow the instructions provided with the kit.

CAUTION

Use caution while preparing. The indicator reagent is corrosive and can stain clothing. Wear protective gloves, clothing and eye protection when replacing or installing the reagent kits.

NOTICE

Once mixed the reagents have an expected life of 30 days. Write the mixing date on the reagent bottle labels in the area provided. Contact your local authorities regarding disposal methods permitted in your jurisdiction.

6. Install the new reagents in the CLX. Be sure to install them in the correct location as labeled on the inside of the CLX. Hold the cap and twist the bottle to install.
7. Select the reagent priming function by pressing Enter to have the instrument start the priming. This will draw enough of each reagent to completely prime the tubes and replace any old solution. If chlorine is in the sample water, you should see pink water coming out of the drain by the end of the prime cycle.
8. Once it is completely primed, click the Exit button to return to the Home screen and begin normal operation.

10.5 Check Valve Flushing Kit

Sometimes upon initial commissioning, the check valves stick and require manual priming. Be careful when using this kit to use only chlorine free water. Complete instructions are included in the kit.

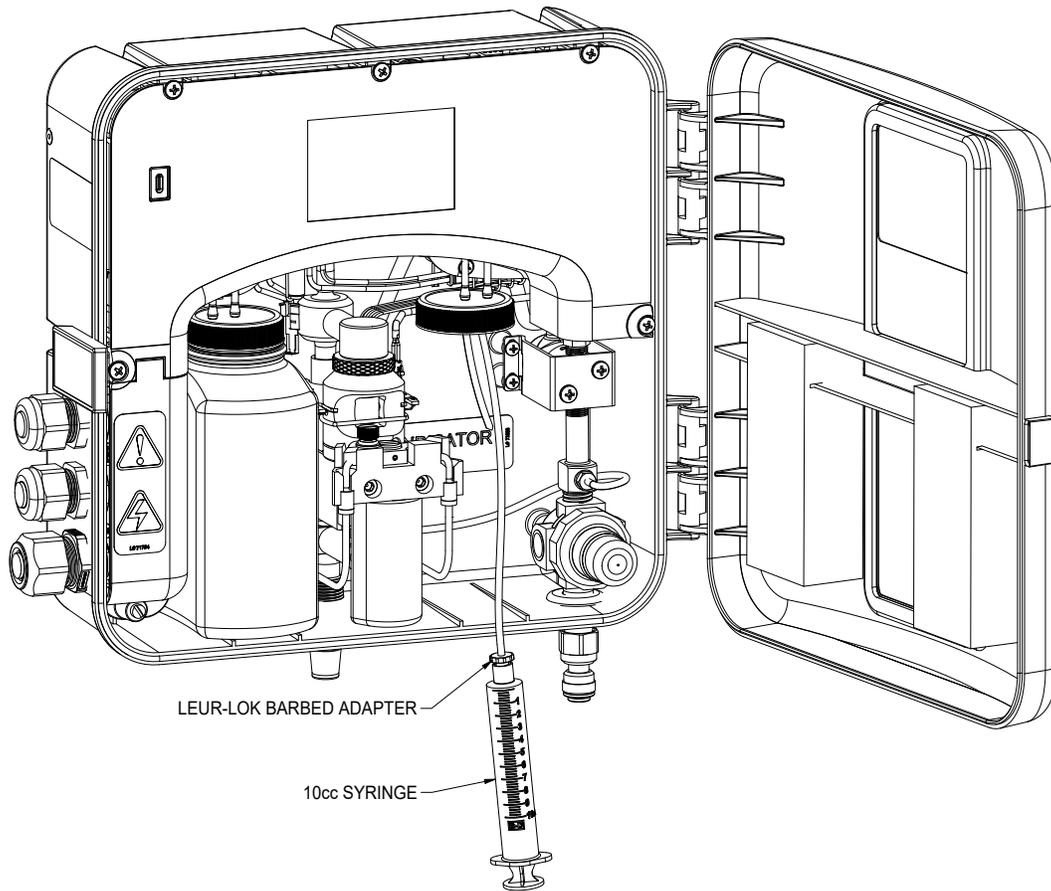

Figure 9: Check Valve Flushing Kit

10.6 Instrument Storage



If the CLX is relocated or will be inactive for more than 48 hours, remove the reagents. Flush the reagent system as describe in *10.1 Maintenance Schedule*. Place the instrument in Service mode to drain the system, then remove power by disconnecting the mains power plug.

Finally, shut off the source water to the CLX.

10.7 Cleaning the CLX



Flush the system as mentioned in Section *10.1 Maintenance Schedule*. When the flushing is finished, press the Exit button to return to Home screen.

As a matter of safety, always disconnect any power source to the CLX prior to attempting any cleaning. It is recommended that the source water is also shut off.

Isopropyl alcohol (rubbing alcohol) on a soft cotton cloth works very well in removing reagent stains from plastic parts, the keypad and the display. Use care when cleaning around electrical components. Do not use any harsh cleaning agents as these may cause damage to the instrument components.

Ensure that the system is dry prior to applying power.

11.0 Accessories and Replacement Parts List

The items shown below are recommended accessories and replacement parts.

Accessory	Catalog Number	Photo
J.A.W. Reagent Kit – Free Chlorine 30 day supply	09951	
J.A.W. Reagent Kit – Total Chlorine 30 day supply	09952	
Liquid Reagent Kit - Free Chlorine 30 day supply	09947	
Liquid Reagent Kit - Total Chlorine 30 day supply	09954	
Operating Manual CLX	24420	N/A
Tubing/Cuvette Kit	09950	
Replacement T-Strainer Screen	28145S	

Continued

Accessory	Catalog Number	Photo
Replacement Cuvette	25018S	
Check Valve Set	25017S	
Ferrite for 4-20mA or RS-485	24560	
Check Valve Flushing Kit	25096	
Chassis Assembly With Wiring	110230S	

To order any accessory or replacement part, please contact the HF scientific Customer Service Department. If for any reason technical assistance is needed regarding this instrument, please do not hesitate to contact the HF scientific Technical Services Department.

HF scientific

16260 Airport Park Drive, Suite 140

Fort Myers, Florida 33913

Phone: (239) 337-2116

Fax: (239) 454-0694

Toll Free: 888-203-7248

Email: HF.Info@Wattswater.com

www.hfscientific.com

NOTICE

Watts is not responsible for failure of alerts due to connectivity issues, power issues, or improper installation.

12.0 Warranty

Watts Regulator Co. (the "Company") warrants each municipal market instrument product to be free from defects in material and workmanship under normal usage for a period of two (2) years from date of the Company's invoice from the original sale of the product, whichever occurs first. In the event of such defects within the warranty period, the Company will, at its option, replace or recondition the product without charge. Parts which by their nature are normally required to be replaced periodically, consistent with normal maintenance, specifically reagents, desiccant, sensors, electrodes and fuses, are excluded. Also excluded are accessories and supply-type items.

Proof of purchase from the Company (Company invoice or paid order confirmation) and/or first use (commissioning) must be provided when making a product warranty claim.

THE WARRANTY SET FORTH HEREIN IS GIVEN EXPRESSLY AND IS THE ONLY WARRANTY GIVEN BY THE COMPANY WITH RESPECT TO THE PRODUCT. THE COMPANY MAKES NO OTHER WARRANTIES, EXPRESSED OR IMPLIED. THE COMPANY HEREBY SPECIFICALLY DISCLAIMS ALL OTHER WARRANTIES, EXPRESSED OR IMPLIED, INCLUDING BUT NOT LIMITED TO, THE IMPLIED WARRANTIES OF MERCHANTABILITY AND FITNESS FOR A PARTICULAR PURPOSE.

The remedy described in the first paragraph of this warranty shall constitute the sole and exclusive remedy for breach of warranty, and the Company shall not be responsible for any incidental, special or consequential damages, including without limitation, lost profits or the cost of repairing or replacing other property which is damaged if this product does not work properly, other costs resulting from labor charges, delays, vandalism, negligence, fouling caused by foreign material, damage from adverse water conditions, chemical, or any other circumstances over which the Company has no control. In addition, the Company shall not be responsible for any costs incidental to the Company's warranty response efforts, including, without limitation, costs associated with the removal and replacement of systems, structures or other parts of facilities, de-installation, decontamination and re-installation of products, or transportation of products to and from the Company. This warranty shall be invalidated by any abuse, misuse, misapplication, improper installation or improper maintenance of the product, alteration of the product or use of any parts or accessories (including but not limited to reagents) not provided by the Company.

Some states do not allow limitations on how long an implied warranty lasts, and some states do not allow the exclusion or limitation of incidental or consequential damages. Therefore the above limitations may not apply to you. This Limited Warranty gives you specific legal rights, and you may have other rights that vary from State to State. You should consult applicable state laws to determine your rights. **SO FAR AS IS CONSISTENT WITH APPLICABLE STATE LAW, ANY IMPLIED WARRANTIES THAT MAY NOT BE DISCLAIMED, INCLUDING THE IMPLIED WARRANTIES OF MERCHANTABILITY AND FITNESS FOR A PARTICULAR PURPOSE, ARE LIMITED IN DURATION TO ONE YEAR FROM THE DATE OF ORIGINAL SHIPMENT.**



A WATTS Brand

USA: T: (239) 337-2116 • Toll-Free (888) 203-7248 • F: (239) 454-0694 • HFscientific.com
Latin America: T: (52) 55-4122-0138 • HFscientific.com

